

**PILOT'S OPERATING HANDBOOK
AND FAA APPROVED
AIRPLANE FLIGHT MANUAL**

for the

Beechcraft.

Baron

95-55

and

Serials TC-1 thru TC-501
except
TC-350 and TC-371

95-A55

FAA APPROVED IN THE NORMAL CATEGORY BASED ON CAR 3. THIS DOCUMENT MUST BE CARRIED IN THE AIRPLANE AT ALL TIMES AND BE KEPT WITHIN REACH OF THE PILOT DURING ALL FLIGHT OPERATIONS.

THIS HANDBOOK INCLUDES THE MATERIAL REQUIRED TO BE FURNISHED TO THE PILOT BY FAR PART 23.

Mr's Serial No. _____

Registration No. _____

FAA Approved by: Donald H. Peter

For

W. H. SCHULTZ
BEECH AIRCRAFT CORPORATION
DOA CE-2

THIS HANDBOOK SUPERSEDES ALL BEECH PUBLISHED OWNER'S MANUALS, FLIGHT MANUALS, AND CHECK LISTS ISSUED FOR THIS AIRPLANE WITH THE EXCEPTION OF FAA APPROVED AIRPLANE FLIGHT MANUAL SUPPLEMENTS.

P/N 55-590000-65B

Reissued: June, 1982

PUBLISHED BY
COMMERCIAL PRODUCT SUPPORT
BEECH AIRCRAFT CORPORATION
WICHITA KANSAS 67201
U. S. A.



Member of GAMA
General Aviation
Manufacturers Association

A Raytheon Company

**Baron 55, A55 Pilot's Operating
Handbook and FAA Approved
Airplane Flight Manual**

ORIGINAL (A) NOVEMBER 1978
REISSUE (B) JUNE 1982

LOG OF REVISIONS

PAGE	DESCRIPTION OF REVISION
Title Page	
Logo Page	
Page A	
a thru b	
1-1 thru 1-22	
2-1 thru 2-32	
3-1 thru 3-16	
4-1 thru 4-26	
5-1 thru 5-48	
6-1 thru 6-24	
7-1 thru 7-40	
8-1 thru 8-58	
Section 9	See Log of Supplements
10-1 thru 10-67	March 1981
	B



**Baron 55, A55 Pilot's Operating
Handbook and FAA Approved
Airplane Flight Manual**

INTRODUCTION

The format and contents of this Pilot's Operating Handbook and FAA Approved Airplane Flight Manual conform to GAMA (General Aviation Manufacturers Association) Handbook Specification Number 1. Use of this specification by all manufacturers will provide the pilot with the same type of data in the same place in all handbooks.

In recent years, BEECHCRAFT handbooks contained most of the data now provided. However, the new handbooks contain more detailed data and some entirely new data.

For example, attention is called to Section X (SAFETY INFORMATION). BEECHCRAFT feels it is highly important to have SAFETY INFORMATION in a condensed form in the hands of the pilots. The SAFETY INFORMATION should be read and studied. Periodic review will serve as a reminder of good piloting techniques.

**Baron 55, A55 Pilot's Operating
Handbook and FAA Approved
Airplane Flight Manual**

TABLE OF CONTENTS

SECTION 1 General

SECTION 2 Limitations

SECTION 3 Emergency Procedures

SECTION 4 Normal Procedures

SECTION 5 Performance

SECTION 6 Weight and Balance/Equipment List

SECTION 7 Systems Description

SECTION 8 Handling, Servicing and Maintenance

SECTION 9 Supplements

SECTION 10 Safety Information

**BEEHCRAFT Baron 55, A55
Serial TC-1 thru TC-501**

SECTION I

GENERAL

TABLE OF CONTENTS

<i>SUBJECT</i>	<i>PAGE</i>
Important Notice	1-3
Use of the Handbook	1-4
Revising the Handbook	1-7
Supplements Revision Record	1-7
Vendor Issued STC Supplements	1-8
Airplane Three View	1-9
Ground Turning Clearance	1-10
Descriptive Data	1-11
Engines	1-11
Propellers	1-11
Fuel	1-12
Standard System	1-12
Optional System	1-12
Oil	1-12
Maximum Certificated Weights	1-12
Cabin and Entry Dimensions	1-12
Baggage Space	1-12
Specific Loadings	1-13
Symbols, Abbreviations and Terminology	1-13
Airspeed Terminology	1-13
Meteorological Terminology	1-16
Power Terminology	1-17
Engine Controls and Instruments Terminology	1-17

Section I
General

BEEHCRAFT Baron 55, A55
Serial TC-1 thru TC-501

TABLE OF CONTENTS (Continued)

<i>SUBJECT</i>	<i>PAGE</i>
Airplane Performance and Flight	
Planning Terminology	1-18
Weight and Balance Terminology	1-19

THANK YOU . . . for displaying confidence in us by selecting a BEECHCRAFT airplane. Our design engineers, assemblers and inspectors have utilized their skills and years of experience to ensure that the BEECHCRAFT Baron meets the high standards of quality and performance for which BEECHCRAFT airplanes have become famous throughout the world.

IMPORTANT NOTICE

This handbook must be read carefully by the owner and operator in order to become familiar with the operation of the BEECHCRAFT Baron. The handbook presents suggestions and recommendations to help obtain safe and maximum performance without sacrificing economy. The BEECHCRAFT Baron must be operated according to the Pilot's Operating Handbook and FAA Approved Airplane Flight Manual, and/or placards located in the airplane.

As a further reminder, the owner and operator of this airplane should also be familiar with the Federal Aviation Regulations applicable to the operation and maintenance of the airplane and FAR Part 91 General Operating and Flight Rules. Further, the airplane must be operated and maintained in accordance with FAA Airworthiness Directives which may be issued against it.

The Federal Aviation Regulations place the responsibility for the maintenance of this airplane on the owner and the operator who must ensure that all maintenance is done by qualified mechanics in conformity with all airworthiness requirements established for this airplane.

All limits, procedures, safety practices, time limits, servicing, and maintenance requirements contained in this handbook are considered mandatory for the continued

Section I
General

BEEHCRAFT Baron 55, A55
Serial TC-1 thru TC-501

airworthiness of this airplane, in a condition equal to that of its original manufacture.

Authorized BEEHCRAFT Aero or Aviation Centers or International Distributors or Dealers can provide recommended modification, service, and operating procedures issued by both FAA and Beech Aircraft Corporation, which are designed to get maximum utility and safety from this airplane.

USE OF THE HANDBOOK

The Pilot's Operating Handbook is designed to maintain documents necessary for the safe and efficient operation of the Baron. The handbook has been prepared in loose leaf form for ease in maintenance and in a convenient size for storage. The handbook has been arranged with quick reference tabs imprinted with the title of each section and contains ten basic divisions:

Section 1 General

Section 2 Limitations

Section 3 Emergency Procedures

Section 4 Normal Procedures

Section 5 Performance

Section 6 Weight and Balance/Equipment List

Section 7 Systems Description

Section 8 Handling, Servicing and Maintenance

Section 9 Supplements

Section 10 Safety Information

NOTE

Except as noted, all airspeeds quoted in this handbook are Indicated Airspeeds (IAS) and assume zero instrument error.

In an effort to provide as complete coverage as possible, applicable to any configuration of the airplane, some optional equipment has been included in the scope of the handbook. However, due to the variety of airplane appointments and arrangements available, optional equipment described and depicted herein may not be designated as such in every case.

The following information may be provided to the holder of this manual automatically:

1. Original issues and revisions of Class I and II Service Instructions.
2. Original issues and revisions of FAA Approved Airplane Flight Manual Supplements.
3. Reissues and Revisions of FAA Approved Airplane Flight Manuals, Flight Handbooks, Owner's Manuals, Pilot's Operating Manuals and Pilot's Operating Handbooks.

This service is free and will be provided only to holders of this handbook who are listed on the FAA Aircraft Registration Branch List or the BEECHCRAFT International Owners Notification Service List, and then only if you are listed by airplane serial number for the model

Section I
General

BEECHCRAFT Baron 55, A55
Serial TC-1 thru TC-501

for which this handbook is applicable. For detailed information on how to obtain "Revision Service" applicable to this handbook or other BEECHCRAFT Service Publications consult a BEECHCRAFT Aero or Aviation Center or International Distributor or Dealer or refer to the latest revision of BEECHCRAFT Service Instructions No. 0250-010.

BEECH AIRCRAFT CORPORATION EXPRESSLY RESERVES THE RIGHT TO SUPERSEDE, CANCEL, AND/OR DECLARE OBSOLETE, WITHOUT PRIOR NOTICE, ANY PART, PART NUMBER, KIT OR PUBLICATION REFERENCED IN THIS HANDBOOK.

The owner/operator should always refer to all supplements, whether STC Supplements or Beech Supplements, for possible placards, limitations, normal, emergency and other operational procedures for proper operation of the airplane with optional equipment installed.

REVISING THE HANDBOOK

Immediately following the title page is the "Log of Revisions" page(s). The Log of Revisions pages are used for maintaining a listing of all effective pages in the handbook (except the SUPPLEMENTS section), and as a record of revisions to these pages. In the lower right corner of the outlined portion of the Log of Revisions is a box containing a capital letter which denotes the issue or reissue of the handbook. This letter may be suffixed by a number which indicates the numerical revision. When a revision to any information in the handbook is made, a new Log of Revisions will be issued. All Logs of Revisions must be retained in the handbook to provide a current record of material status until a reissue is made.

WARNING

When this handbook is used for airplane operational purposes, it is the pilot's responsibility to maintain it in current status.

AIRPLANE FLIGHT MANUAL SUPPLEMENTS REVISION RECORD

Section IX contains the FAA Approved Airplane Flight Manual Supplements headed by a Log of Supplements page. On the "Log" page is a listing of the FAA Approved Supplemental Equipment available for installation on the airplane. When new supplements are received or existing supplements are revised, a new "Log" page will replace the previous one, since it contains a listing of all previous approvals, plus the new approval. The supplemental material will be added to the grouping in accordance with the descriptive listing.

Section I
General

BEEHCRAFT Baron 55, A55
Serial TC-1 thru TC-501

NOTE

Upon receipt of a new or revised supplement, compare the "Log" page just received with the existing "Log" page in the manual. Retain the "Log" page with the latest date on the bottom of the page and discard the other log.

VENDOR-ISSUED STC SUPPLEMENTS

When a new airplane is delivered from the factory, the handbook delivered with it contains either an STC (Supplemental Type Certificate) Supplement or a Beech Flight Manual Supplement for every installed item requiring a supplement. If a new handbook for operation of the airplane is obtained at a later date, it is the responsibility of the owner/operator to ensure that all required STC Supplements (as well as weight and balance and other pertinent data) are transferred into the new handbook.

BEECHCRAFT Baron 55, A55
Serial TC-1 thru TC-501

Section I
General

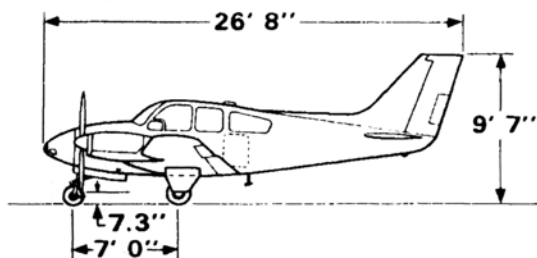
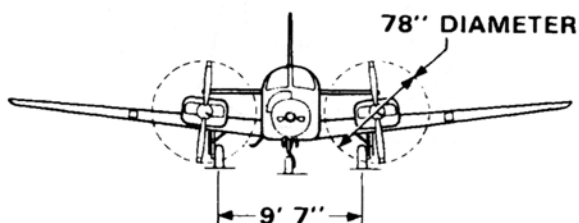
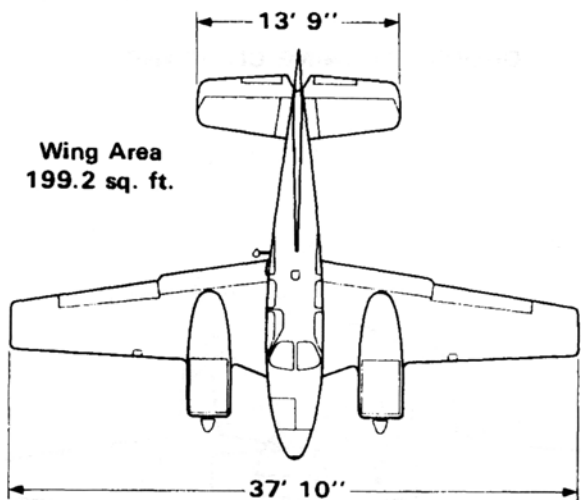

AIRPLANE THREE-VIEW

GROUND TURNING CLEARANCE

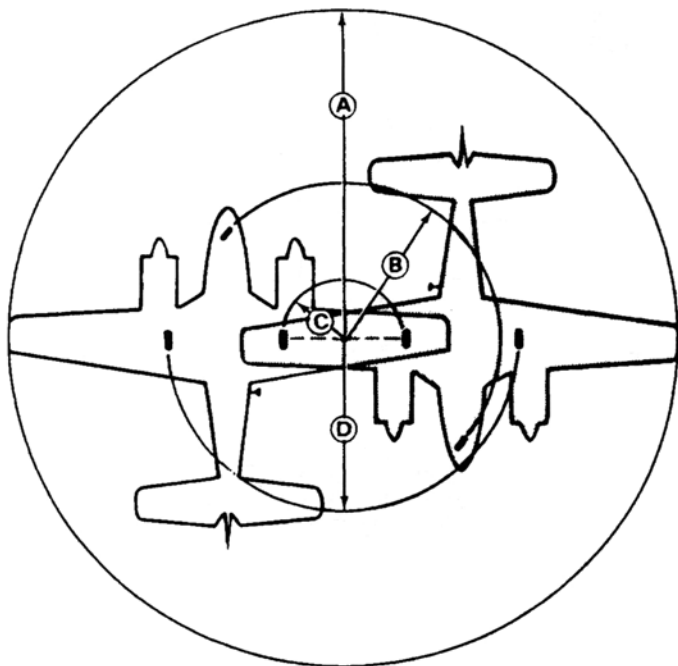

- (A) Radius for Wing Tip 29 feet 6 inches
- (B) Radius for Nose Wheel 12 feet 2 inches
- (C) Radius for Inside Gear 5 feet 9 inches
- (D) Radius for Outside Gear 15 feet 7 inches

TURNING RADII ARE PREDICATED ON THE USE OF PARTIAL BRAKING ACTION AND DIFFERENTIAL POWER.

DESCRIPTIVE DATA

ENGINES

Two Continental IO-470-L fuel injected, air cooled six-cylinder, horizontally-opposed engines each rated at 260 horsepower at 2625 rpm.

Take-off and Maximum

Continuous Power Full throttle and 2625 rpm

Maximum One-Engine

Inoperative Power Full throttle and 2625 rpm

Cruise Climb Power 25.0 in. Hg at 2500 rpm

Maximum Cruise Power 24.5 in. Hg at 2450 rpm

PROPELLERS

McCAULEY

2 Blade Hubs: 2AF36C39

Blades: 78BF-0 or 78BFM-0

Pitch Setting at 30 inch Station:

Low 14.6°; High 83.0°

Diameter: 78 inches maximum, 76 inches minimum

or

2 Blade Hubs: 2AF36C89

Blades: 78BFS-0

Pitch Setting at 30 inch Station:

Low 15°; High 79°

Diameter: 78 inches maximum, 76 inches minimum

or

2 Blade Hubs: 2AF34C55

Blades: 78FF-0

Pitch Setting at 30 inch Station:

Low 15°; High 79°

Diameter: Maximum 78 inches, minimum 76 inches

NOTE

Other propellers are approved and are listed in the FAA Aircraft Specification 3A16 or are approved by Supplemental Type Certificate.

**Section I
General**

**BEECHCRAFT Baron 55, A55
Serial TC-1 thru TC-501**

FUEL

Aviation Gasoline 100LL (blue) preferred, 100 (green) minimum grade.

STANDARD SYSTEM (Main and Auxiliary):

Total Capacity 112 Gallons
Total Usable 106 Gallons

OPTIONAL SYSTEM (Main and Auxiliary):

Total Capacity 142 Gallons
Total Usable 136 Gallons

OIL

The oil capacity is 12 quarts for each engine.

WEIGHTS

Maximum Ramp Weight 4901 lbs
Maximum Take-Off Weight 4880 lbs
Maximum Landing Weight 4880 lbs

CABIN AND ENTRY DIMENSIONS

Length 8 ft 6 in.
Height (Max.) 4 ft 2 in.
Width (Max.) 3 ft 6 in.
Entrance Door 37 in. x 36 in.

BAGGAGE SPACE AND ENTRY DIMENSIONS

Main Cabin Compartment 33.5 cu ft
Standard Baggage Door 18.5 in. x 22.5 in.
Optional Baggage Door 38 in. x 22.5 in.
Nose Compartment 12 cu ft

**SPECIFIC LOADINGS (Maximum Take-Off
Weight)**

Wing Loading	24.5 lbs/sq ft
Power Loading	9.4 lbs/hp

**SYMBOLS, ABBREVIATIONS AND
TERMINOLOGY**

The following Abbreviations and Terminologies have been listed for convenience and ready interpretation where used within this handbook. Whenever possible, they have been categorized for ready reference.

AIRSPPEED TERMINOLOGY

- CAS** Calibrated Airspeed is the indicated airspeed of an airplane, corrected for position and instrument error. Calibrated airspeed is equal to true airspeed in standard atmosphere at sea level.

- GS** Ground Speed is the speed of an airplane relative to the ground.

- IAS** Indicated Airspeed is the airspeed of an airplane as shown on the airspeed indicator. IAS values published in this handbook assume zero instrument error.

- TAS** True Airspeed is the airspeed of an airplane relative to undisturbed air, which is the CAS corrected for altitude, temperature, and compressibility.

Section I
General

BEECHCRAFT Baron 55, A55
Serial TC-1 thru TC-501

- V_{MCA} Air minimum control speed is the minimum flight speed at which the airplane is directionally controllable as determined in accordance with Federal Aviation Regulations. The airplane certification conditions include one engine becoming inoperative and windmilling; a 5° bank towards the operative engine; takeoff power on operative engine; landing gear up; flaps up; and most rearward C.G. For some conditions of weight and altitude, stall can be encountered at speeds above V_{MCA} as established by the certification procedure described above, in which event stall speed must be regarded as the limit of effective directional control.
- V_{SSE} The Intentional One-Engine-Inoperative Speed is a speed above both V_{MCA} and stall speed, selected to provide a margin of lateral and directional control when one engine is suddenly rendered inoperative. Intentional failing of one engine below this speed is not recommended.
- V_A Maneuvering Speed is the maximum speed at which application of full available aerodynamic control will not overstress the airplane.
- V_F Design flap speed is the highest speed permissible at which wing flaps may be actuated.
- V_{FE} Maximum Flap Extended Speed is the highest speed permissible with wing flaps in a prescribed extended position.

- V_{LE} Maximum Landing Gear Extended Speed is the maximum speed at which an airplane can be safely flown with the landing gear extended.
- V_{LO} Maximum Landing Gear Operating Speed is the maximum speed at which the landing gear can be safely extended or retracted.
- V_{NE} Never Exceed Speed is the speed limit that may not be exceeded at any time.
- V_{NO} or V_C Maximum Structural Cruising Speed is the speed that should not be exceeded except in smooth air and then only with caution.
- V_S Stalling Speed or the minimum steady flight speed at which the airplane is controllable.
- V_{SO} Stalling Speed or the minimum steady flight speed at which the airplane is controllable in the landing configuration.
- V_X Best Angle-of-Climb Speed is the airspeed which delivers the greatest gain of altitude in the shortest possible horizontal distance.
- V_Y Best Rate-of-Climb Speed is the airspeed which delivers the greatest gain in altitude in the shortest possible time.

METEOROLOGICAL TERMINOLOGY

ISA	<p>International Standard Atmosphere in which</p> <ol style="list-style-type: none">(1) The air is a dry perfect gas;(2) The temperature at sea level is 15° Celsius (59° Fahrenheit);(3) The pressure at sea level is 29.92 in. Hg (1013.2 millibars);(4) The temperature gradient from sea level to the altitude at which the temperature is -56.5° C (-69.7° F) is -0.00198° C (-0.003566° F) per foot and zero above that altitude.
OAT	<p>Outside Air Temperature is the free air static temperature, obtained either from inflight temperature indications adjusted for instrument error and compressibility effects, or ground meteorological sources.</p>
Indicated Pressure Altitude	<p>The number actually read from an altimeter when the barometric sub-scale has been set to 29.92 in. Hg (1013.2 millibars).</p>
Pressure Altitude	<p>Altitude measured from standard sea-level pressure (29.92 in. Hg) by a pressure or barometric altimeter. It is the indicated pressure altitude corrected for position and instrument error. In this Handbook, altimeter instrument errors are assumed to be zero. Position errors may be obtained from the Altimeter Correction Chart.</p>

Station Pressure	Actual atmospheric pressure at field elevation.
Wind	The wind velocities recorded as variables on the charts of this handbook are to be understood as the headwind or tailwind components of the reported winds.

POWER TERMINOLOGY

Take-off and Maximum Continuous	The highest power rating not limited by time.
Cruise Climb	Power recommended for cruise climb.
Maximum Cruise	The highest power settings recommended for cruise.
Recommended Cruise	Intermediate power settings for which cruise power settings are presented.
Economy Cruise	The lowest power setting for which cruise power settings are presented.

ENGINE CONTROLS AND INSTRUMENTS TERMINOLOGY

Throttle Controls	The lever used to control the introduction of a fuel-air mixture into the intake passages of an engine.
-------------------	---

**Section I
General**

**BEECHCRAFT Baron 55, A55
Serial TC-1 thru TC-501**

- Propeller Controls** This lever requests the governor to maintain rpm at a selected value and, in the maximum decrease rpm position, feathers the propellers.
- Mixture Controls** This lever, in the idle cut-off position, stops the flow of fuel at the injectors and in the intermediate thru the full rich positions, regulates the fuel air mixture.
- Propeller Governors** The governors maintain the selected rpm requested by the propeller control levers.
- Manifold Pressure Gage** An instrument that measures the absolute pressure in the intake manifold of an engine, expressed in inches of mercury (in. Hg).
- Tachometers** An instrument that indicates the rotational speed of the propeller (and engine) in revolutions per minute (rpm).

**AIRPLANE PERFORMANCE AND
FLIGHT PLANNING TERMINOLOGY**

- Climb Gradient** The ratio of the change in height during a portion of a climb, to the horizontal distance traversed in the same time interval.

**BEECHCRAFT Baron 55, A55
Serial TC-1 thru TC-501**

**Section I
General**

Demonstrated Crosswind Velocity	The maximum 90° crosswind component for which adequate control of the airplane during take-off and landing was actually demonstrated during certification tests.
Accelerate-Stop Distance	The distance required to accelerate to a specified speed and, assuming failure of an engine at the instant that speed is attained, to bring the airplane to a stop.
Accelerate-Go Distance	The distance required to accelerate to a specified speed and, assuming failure of an engine at the instant that speed is attained, feather inoperative propeller and continue takeoff on the remaining engine to a height of 50 feet.
MEA	Minimum enroute IFR altitude.
Route Segment	A part of a route. Each end of that part is identified by: (1) a geographical location; or (2) a point at which a definite radio fix can be established.
GPH	U.S. Gallons per hour.

WEIGHT AND BALANCE TERMINOLOGY

Reference Datum	An imaginary vertical plane from which all horizontal distances are measured for balance purposes.
-----------------	--

Section I
General

BEECHCRAFT Baron 55, A55
Serial TC-1 thru TC-501

Station	A location along the airplane fuselage usually given in terms of distance from the reference datum.
Arm	The horizontal distance from the reference datum to the center of gravity (C.G.) of an item.
Moment	The product of the weight of an item multiplied by its arm. (Moment divided by a constant is used to simplify balance calculations by reducing the number of digits.)
Airplane Center of Gravity (C.G.)	The point at which an airplane would balance if suspended. Its distance from the reference datum is found by dividing the total moment by the total weight of the airplane.
C.G. Arm	The arm obtained by adding the airplane's individual moments and dividing the sum by the total weight.
C.G. Limits	The extreme center of gravity locations within which the airplane must be operated at a given weight.
Usable Fuel	Fuel available for flight planning.
Unusable Fuel	Fuel remaining after a runout test has been completed in accordance with governmental regulations.
Standard Empty Weight	Weight of a standard airplane including unusable fuel, full operating fluids and full oil.

**BEECHCRAFT Baron 55, A55
Serial TC- 1 thru TC-501**

**Section I
General**

Basic Empty Weight	Standard empty weight plus optional equipment.
Payload	Weight of occupants, cargo and baggage.
Useful Load	Difference between ramp weight and basic empty weight.
Maximum Ramp Weight	Maximum weight approved for ground maneuvering. (It includes weight of start, taxi, and run up fuel).
Maximum Take-off Weight	Maximum weight approved for the start of the take off run.
Maximum Landing Weight	Maximum weight approved for the landing touchdown.
Zero Fuel Weight	Weight exclusive of usable fuel.

**Section I
General**

**BEECHCRAFT Baron 55, A55
Serial TC-1 thru TC-501**

INTENTIONALLY LEFT BLANK

**BEECHCRAFT Baron 55, A55
Serial TC-1 thru TC-501**

**SECTION II
LIMITATIONS**

TABLE OF CONTENTS

<i>SUBJECT</i>	<i>PAGE</i>
Airspeed Limitations	2-3
Airspeed Indicator Markings	2-4
Power Plant Limitations	2-5
Engines	2-5
Fuel	2-5
Oil	2-5
Propellers	2-6
Starters - Time for Cranking	2-6
Power Plant Instrument Markings	2-7
Miscellaneous Instrument Markings	2-8
Weights	2-8
CG Limits	2-9
Maneuver Limits	2-9
Flight Load Factors (4800 Pounds)	2-9
Minimum Flight Crew	2-9
Kinds of Operation	2-10
Fuel	2-11
Fuel Management	2-11
Oxygen Requirements	2-12
Maximum Passenger Seating	
Configuration	2-12
Seating	2-12
Placards	2-13
Required Equipment for Various	
Conditions of Flight	2-22
June 1982	2-1

**Section II
Limitations**

**BEEHCRAFT Baron 55, A55
Serial TC-1 thru TC-501**

INTENTIONALLY LEFT BLANK

**BEECHCRAFT Baron 55, A55
Serial TC-1 thru TC-501**

**Section II
Limitations**

The limitations included in this section have been approved by the Federal Aviation Administration.

The following limitations must be observed in the operation of this airplane.

AIRSPEED LIMITATIONS

SPEED	CAS		IAS		REMARKS
	KNOTS	MPH	KNOTS	MPH	
Never Exceed V_{NE}	223	257	224	258	Do not exceed this speed in any operation
Maximum Structural Cruising V_{NO} or V_C	182	210	183	211	Do not exceed this speed except in smooth air and then only with caution
Maneuvering V_A	156	180	157	181	Do not make full or abrupt control movements above this speed
Maximum Flap Extension/ Extended V_{FE} (Full down)	113	130	113	130	Do not extend flaps or operate with flaps extended above this speed
Maximum Landing Gear Operating/ Extended V_{LO} and V_{LE}	⊙ 130 ⊙ 143	150 165	130 143	150 165	Do not extend, retract or operate with landing gear extended above this speed
Air Minimum Control Speed V_{MCA}	80	92	78	90	Minimum speed for directional controllability after sudden loss of engine

⊙ Baron 55

○ Baron A55

*AIRSPEED INDICATOR MARKINGS

MARKING	CAS		IAS		SIGNIFICANCE
	KNOTS	MPH	KNOTS	MPH	
White Arc	66-113	76-130	66-113	76-130	Full Flap Operating Range
Blue Radial	101	116	100	115	One-Engine-Inoperative Best Rate-of-Climb Speed
Green Arc	75-182	86-210	78-183	90-211	Normal Operating Range
Yellow Arc	182-223	210-257	183-224	211-258	Operate with caution only in smooth air
Red Radial	223	257	224	258	Maximum speed for ALL operations

*The Airspeed Indicator is marked in CAS values

POWER PLANT LIMITATIONS

ENGINES

Two Continental IO-470-L fuel injected, air cooled six-cylinder, horizontally-opposed engines each rated at 260 horsepower at 2625 rpm.

Take-off and Maximum

continuous power Full throttle, 2625 rpm

Maximum Cylinder Head Temperature 460°F

Maximum Oil Temperature 225°F

Minimum Take-off Oil Temperature 75°F

Minimum Oil Pressure (Idle) 30 psi

Maximum Oil Pressure 80 psi

FUEL

Aviation Gasoline 100LL (blue) preferred, 100 (green) minimum grade.

OIL

Ashless dispersant oils must meet Continental Motors Corporation Specification MHS-24B. Refer to APPROVED ENGINE OILS, Servicing Section.

**Section II
Limitations**

**BEEHCRAFT Baron 55, A55
Serial TC-1 thru TC-501**

PROPELLERS

McCAULEY

2 Blade Hubs: 2AF36C39

Blades: 78BF-0 or 78BFM-0

Pitch Setting at 30 inch Station:

Low 14.6°; High 83.0°

Diameter: 78 inches maximum, 76 inches minimum

or

2 Blade Hubs: 2AF36C89

Blades: 78BFS-0

Pitch Setting at 30 inch Station:

Low 15°; High 79°

Diameter: 78 inches maximum, 76 inches minimum

or

2 Blade Hubs: 2AF34C55

Blades: 78FF-0

Pitch Setting at 30 inch Station:

Low 15°; High 79°

Diameter: Maximum 78 inches, minimum 76 inches

NOTE

Other propellers are approved and are listed in the FAA Aircraft Specification 3A16 or are approved by Supplemental Type Certificate.

STARTERS - TIME FOR CRANKING

Do not operate starter continuously for more than 30 seconds. Allow starter to cool before cranking again.

POWER PLANT INSTRUMENT MARKINGS

OIL TEMPERATURE

Caution (Yellow Radial) 75°F
Operating Range
(Green Arc) 75° to 225°F
Maximum (Red Radial) 225°F

OIL PRESSURE

Minimum Pressure (Red Radial) 30 psi
Operating Range (Green Arc) 30 to 60 psi
Maximum Pressure (Red Radial) 80 psi

FUEL PRESSURE

Minimum (Red Radial) 1.5 psi
Operating Range
(Green Arc) 5 psi to 17.5 psi
Maximum (Red Radial) 17.5 psi

MANIFOLD PRESSURE

Operating Range
(Green Arc) 15 to 29.6 in. Hg
Maximum (Red Radial) 29.6 in. Hg

TACHOMETER

Operating Range (Green Arc) ... 2000 to 2625 rpm
Maximum (Red Radial) 2625 rpm

CYLINDER HEAD TEMPERATURE

Operating Range
(Green Arc) 200° to 460°F
Maximum Temperature
(Red Radial) 460°F

**Section II
Limitations**

**BEECHCRAFT Baron 55, A55
Serial TC-1 thru TC-501**

MISCELLANEOUS INSTRUMENT MARKINGS

INSTRUMENT VACUUM

Baron 55

Minimum (Red Radial)	4.4 in. Hg
Operating Range (Green Arc)	4.8 to 5.2 in. Hg
Maximum (Red Radial)	5.5 in. Hg

Baron A55

Minimum (Red Radial)	3.75 in. Hg
Caution (Yellow Arc)	3.75 to 4.8 in. Hg
Normal (Green Arc)	4.8 to 5.25 in. Hg
Maximum (Red Radial)	5.25 in. Hg

PROPELLER DEICE AMMETER

Normal Operating Range	7 to 12 amps
------------------------------	--------------

FUEL QUANTITY

Yellow Arc (22-Gal Main Tank)	E to 1/2 Full
Yellow Arc (37-Gal Main Tank)	E to 1/4 Full

WEIGHTS

Maximum Ramp Weight	4901 lbs
Maximum Take-Off Weight	4880 lbs
Maximum Landing Weight	4880 lbs

Maximum Baggage/Cargo Compartment Weights:

Main Cabin Compartment (TC-1 thru TC-399 except TC-375, TC-376, TC-377 and TC-393)

(less occupants and equipment)

270 lbs

Main Cabin Compartment (TC-375, TC-376, TC-377, TC-393 and TC-400 thru TC-501)

(less occupants and equipment)

400 lbs

Extended Aft Compartment

120 lbs

Nose Compartment (baggage less

equipment)

270 lbs

Refer to Weight and Balance section for additional information.

CG LIMITS

Forward Limits: 74 inches aft of datum at 3800 lbs and under, then straight line variation to 79.4 inches aft of datum at gross weight of 4880 lbs.

Aft Limits: 86 inches aft of datum at all weights.

REFERENCE DATUM

Datum is 83.1 inches forward of center line through forward jack points.

MAC leading edge is 67.2 inches aft of datum.

MAC length is 63.1 inches.

MANEUVER LIMITS

This is a normal category airplane. Acrobatic maneuvers, including spins, are prohibited.

FLIGHT LOAD FACTORS

Positive maneuvering load factors:

Flaps Up 4.4G

Negative maneuvering load factor:

Flaps Up 3.0G

MINIMUM FLIGHT CREW One pilot

**Section II
Limitations**

**BEECHCRAFT Baron 55, A55
Serial TC-1 thru TC-501**

KINDS OF OPERATION

This airplane is approved for the following type operations when the required equipment is installed and operational as defined herein:

1. VFR day and night
2. IFR day and night
3. FAR 91 operations when all pertinent limitations and performance considerations are complied with.

FUEL

TOTAL FUEL with left and right main and auxiliary fuel systems full:

Standard Fuel System

Capacity	112 Gallons
Usable	106 Gallons

Optional Fuel System

Capacity	142 Gallons
Usable	136 Gallons

FUEL MANAGEMENT

Takeoff and land on main fuel tank only. When operating fuel selector, feel for detent position.

Do not take off if Fuel Quantity Gages indicate in Yellow Arc or with less than 13 gallons in each main tank.

The fuel crossfeed system to be used during emergency conditions in level flight only.

Turning type takeoffs or takeoffs immediately following fast taxi turns are prohibited if the airplane is not equipped with two baffled leading edge fuel tanks or a fuel reservoir in each leading edge fuel tank or a combination of the two.

Maximum slip or skid duration:

20 seconds for airplanes with unbaffled main fuel tanks or without reservoirs in either wing.

30 seconds for airplanes with baffled main fuel tanks or reservoirs in both wings.

**Section II
Limitations**

**BEECHCRAFT Baron 55, A55
Serial TC-1 thru TC-501**

OXYGEN REQUIREMENTS

Refer to FAR 91.32 for oxygen requirements.

MAXIMUM PASSENGER SEATING CONFIGURATION

Five (5) passengers and one (1) pilot

SEATING

All seats must be in the upright position for takeoff and landing.

PLACARDS

*On The Pilot's Window Frame:
(TC-1 thru TC-190)*

**THIS AIRPLANE MUST BE OPERATED AS A
NORMAL CATEGORY AIRPLANE IN COM-
PLIANCE WITH THE OPERATING LIMITA-
TIONS STATED IN THE FORM OF PLACARDS,
MARKINGS, AND MANUALS.**

**NO ACROBATIC MANEUVERS INCLUDING
SPINS APPROVED.**

*On The Pilot's Window Frame (CAS):
(TC-1 thru TC-190)*

AIRSPPEED LIMITATIONS

**MAX SPEED WITH LANDING GEAR EXTENDED (NORMAL) 150 MPH
MAX SPEED WITH FLAPS EXTENDED (NORMAL) 130 MPH
MAX DESIGN MANEUVER SPEED 180 MPH
MIN CONTROL SPEED SINGLE ENGINE 92 MPH**

*Below The Ignition Switch Panel (CAS):
(TC-191 thru TC-501 except TC-350 and TC-371)*

⊕ THIS AIRPLANE MUST BE OPERATED AS A NORMAL CATEGORY AIRPLANE IN COMPLIANCE WITH THE OPERATING LIMITATIONS STATED IN THE FORM OF PLACARDS, MARKINGS, AND MANUALS. ⊕

NO ACROBATIC MANEUVERS INCLUDING SPINS APPROVED

— AIRSPPEED LIMITATIONS —

**MAX SPEED WITH LANDING GEAR EXTENDED (NORMAL) 165 MPH
MAX SPEED WITH FLAPS EXTENDED (NORMAL) 130 MPH
MAX DESIGN MANEUVER SPEED 180 MPH
MIN CONTROL SPEED SINGLE ENGINE 92 MPH**

⊕ ⊕

**Section II
Limitations**

**BEEHCRAFT Baron 55, A55
Serial TC-1 thru TC-501**

PLACARDS (Cont'd)

*On The Pilot's Window Frame:
(TC-1 thru TC-190)*

**EMERGENCY LANDING GEAR
INSTRUCTIONS TO EXTEND**

ENGAGE HANDLE IN REAR OF FRONT SEAT AND TURN COUNTERCLOCKWISE AS FAR AS POSSIBLE (50 TURNS).

On Carpet Cover Between Pilot and Copilot's Chairs: (TC-191 thru TC-391 except TC-350 and TC-371)

**EMERGENCY LANDING GEAR
INSTRUCTIONS TO EXTEND**

ENGAGE HANDLE IN REAR OF FRONT SEAT AND TURN COUNTERCLOCKWISE AS FAR AS POSSIBLE (50 TURNS)

On Carpet Cover Between Pilot and Copilot's Chairs: (TC-392 thru TC-501)

**EMERGENCY
LANDING GEAR
INSTRUCTIONS
TO EXTEND**

ENGAGE HANDLE IN REAR OF FRONT SEAT AND TURN COUNTERCLOCKWISE AS FAR AS POSSIBLE (50 TURNS)

*On Lower Sidewall Adjacent To Pilot:
(TC-1 thru TC-501 except TC-350 and TC-371, OPTIONAL)*

EMERGENCY AIRSPEED STATIC SOURCE

WARNING

**CLOSE STORM WINDOW
SEE FLIGHT MANUAL EMERGENCY
PROCEDURES FOR AIRSPEED-
ALTIMETER CALIBRATION ERROR**

*On The Lower Portion Of The Floating Instrument Panel:
This Placard Is Installed Only When The Airplane Is Not
Equipped With Two Baffled Leading Edge Fuel Tanks Or A
Fuel Reservoir In Each Leading Edge Fuel Tank Or A
Baffled Leading Edge Fuel Tank On The One Side And A
Reservoir Installed In The Leading Edge Tank On The
Other Side*

**TAKE OFF AND LAND ON MAIN TANKS ONLY.
TURNING TYPE TAKEOFFS OR TAKEOFFS IMMEDIATELY
FOLLOWING FAST TAXI TURNS PROHIBITED. REFER
TO FAA FLIGHT MANUAL FOR OTHER FUEL SYSTEM
LIMITATIONS**

On The Floating Instrument Panel:

**DO NOT TAKE OFF IF FUEL QUANTITY GAGES
INDICATE IN YELLOW ARC OR WITH LESS
THAN 13 GALLONS IN EACH MAIN TANK**

**Section II
Limitations**

**BEECHCRAFT Baron 55, A55
Serial TC-1 thru TC-501**

PLACARDS (Cont'd)

*Around The Fuel Selector Handles: (TC-1 thru TC-180-
STANDARD FUEL SYSTEM)*

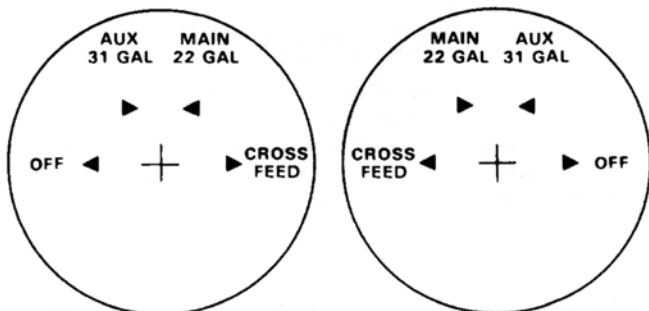

*Around The Fuel Selector Handles: (TC-3 thru TC-180-
OPTIONAL FUEL SYSTEM)*

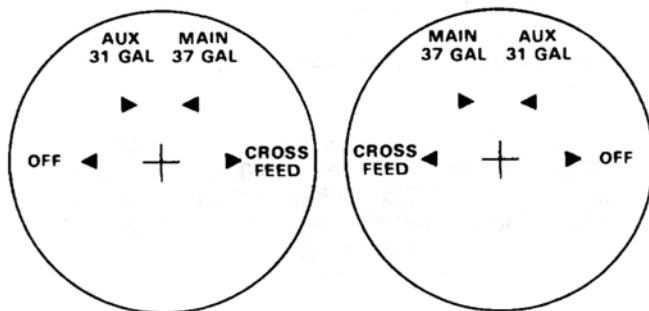

Between The Fuel Selector Handles: (TC-1 thru TC-180)

**USE AUX TANKS AND
CROSSFEED IN LEVEL
FLIGHT ONLY**

**BEECHCRAFT Baron 55, A55
Serial TC-1 thru TC-501**

**Section II
Limitations**

Between The Fuel Selector Handles: (TC-156 thru TC-180)

CAUTION
**DO NOT SELECT
CROSS FEED FROM
BOTH SIDES AT
SAME TIME**

*Between The Fuel Selector Handles: (TC-181 thru TC-501
except TC-350 and TC-371-STANDARD FUEL SYSTEM)*



*Between The Fuel Selector Handles: (TC-181 thru TC-501
except TC-350 and TC-371-OPTIONAL FUEL SYSTEM)*



June 1982

2-17

**Section II
Limitations**

**BEECHCRAFT Baron 55, A55
Serial TC-1 thru TC-501**

PLACARDS (Cont'd)

Oxygen Outlet: All Outlets TC-1 thru TC-357 except TC-350; 3rd, 4th, 5th and 6th Outlets TC-358 thru TC-501 except TC-371

OXYGEN

Pilot Outlet TC-358 thru TC-501 except TC-371

**PILOT
OXYGEN**

Co-pilot Outlet TC-358 thru TC-501 except TC-371

**COPILOT
OXYGEN**

*On Instrument Panel (TC-1 thru TC-357 except TC-350)
On Oxygen Console (TC-358 thru TC-501 except TC-371)*

WARNING

**DO NOT SMOKE WHILE OXYGEN IS IN USE
HOSE PLUG MUST BE PULLED OUT TO
STOP FLOW OF OXYGEN**

*Adjacent To Cabin Door Handle:
(TC-1 thru TC-190)*

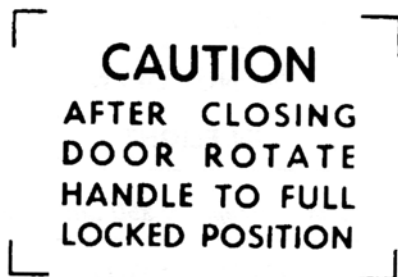

*Adjacent To Cabin Door Handle:
(TC-191 thru TC-501 except TC-350 and TC-371)*

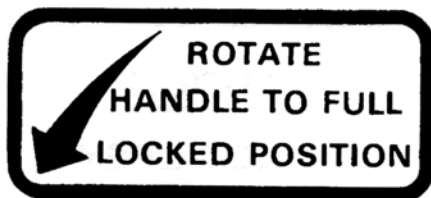

*On Left Cabin Sidewall Below Window Sill And Close To
Emergency Exit Release Handle: (TC-238 thru TC-501
except TC-350 and TC-371)*

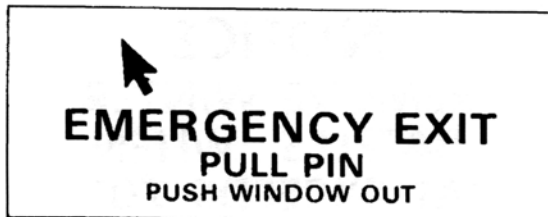

**Section II
Limitations**

**BEECHCRAFT Baron 55, A55
Serial TC-1 thru TC-501**

PLACARDS (Cont'd)

On Openable Cabin Windows:

**DO NOT OPEN
IN FLIGHT**

(TC-191 thru TC-501 except TC-350 and TC-371)

**LATCH WINDOW
BEFORE TAKE-OFF**

On Storm Window (CAS):

**CAUTION
DO NOT OPEN
ABOVE 145 MPH**

On Fuel Selector Panel:

**NOTICE
REMOVE WINTER
BAFFLES WHEN
OAT EXCEEDS 70° F**

**BEEHCRAFT Baron 55, A55
Serial TC-1 thru TC-501**

**Section II
Limitations**

On Inside Of The Rear Baggage Compartment Door: (TC-1 thru TC-399 except TC-371, TC-375, TC-376, TC-377, TC-393 and TC-350)



On Inside Of The Rear Baggage Compartment Door: (used with 5th and 6th seat installation - TC-238 thru TC-399 except TC-371, TC-375, TC-376, TC-377, TC-393 and TC-350)



On Inside Of The Rear Baggage Compartment Door: (TC-375, TC-376, TC-377, TC-393 and TC-400 thru TC-501)



**Section II
Limitations**

**BEECHCRAFT Baron 55, A55
Serial TC-1 thru TC-501**

PLACARDS (Cont'd)

In Plain View When Nose Baggage Compartment Door Is Open:



**REQUIRED EQUIPMENT FOR VARIOUS
CONDITIONS OF FLIGHT**

Part 91 of the Federal Aviation Regulations specifies the minimum numbers and types of airplane instruments and equipment which must be installed and operable for various kinds of flight conditions. This includes VFR day, VFR night, IFR day, and IFR night.

Regulations also require that all airplanes be certificated by the manufacturer for operations under various flight conditions. At certification, all required equipment must be in operating condition and should be maintained to assure continued airworthiness. If deviations from the installed equipment were not permitted, or if the operating rules did not provide for various flight conditions, the airplane could not be flown unless all equipment was operable. With appropriate limitations, the operation of every system or component installed in the airplane is not necessary, when the remaining operative instruments and equipment provide for continued safe operation. Operation in accordance with limitations established to maintain airworthiness, can permit continued or uninterrupted operation of the airplane temporarily.

For the sake of brevity, the Required Equipment Listing does not include obviously required items such as wings, rudders, flaps, engine, landing gear, etc. Also the list does not include items which do not affect the airworthiness of the airplane such as galley equipment, entertainment systems, passenger convenience items, etc. However, it is important to note that ALL ITEMS WHICH ARE RELATED TO THE AIRWORTHINESS OF THE AIRPLANE AND NOT INCLUDED ON THE LIST ARE AUTOMATICALLY REQUIRED TO BE OPERATIVE.

To enable the pilot to rapidly determine the FAA equipment requirements necessary for a flight into specific conditions, the following equipment requirements and exceptions are presented. It is the final responsibility of the pilot to determine whether the lack of, or inoperative status of a piece of equipment on his airplane, will limit the conditions under which he may operate the airplane.

WARNING

FLIGHT IN ICING CONDITIONS IS PROHIBITED.

LEGEND

Numbers refer to quantities required to be operative for a specified condition.

(-) Indicates that the item may be inoperative for the specified condition.

(*) Refers to the REMARKS AND/OR EXCEPTIONS column for explicit information or reference.

Required Equipment Charts are to be found on the pages that follow.

**Section II
Limitations**

**BEECHCRAFT Baron 55, A55
Serial TC-1 thru TC-501**

SYSTEM and/or COMPONENT	Number Installed						Remarks and / or Exceptions
	VFR Day		VFR Night		IFR Night		
GENERAL							
Overwater flight	*	*	*	*	*		- *Per FAR 91
COMMUNICATIONS							
VHF communications system	*	*	*	*	*		- *Per FAR 91
ELECTRICAL POWER							
Battery	1	1	1	1	1		-
DC generator	2	1	2	2	2		-
DC loadmeter	2	2	2	2	2		-

**BEECHCRAFT Baron 55, A55
Serial TC-1 thru TC-501**

**Section II
Limitations**

EQUIPMENT AND FURNISHING									
Seat belts and shoulder harness	*	*	*	*	*	*	*	*	-*Per FAR 91, all seats
Emergency locator transmitter	1	1	1	1	1	1	1	1	- Per FAR 91
FIRE PROTECTION									
Portable fire extinguisher	*	*	*	*	*	*	*	*	-*Optional
FLIGHT CONTROLS									
Trim tab indicators - Rudder, aileron, and elevator	3	3	3	3	3	3	3	3	-
Flap position indication lights	2	2	2	2	2	2	2	2	-
Stall warning	1	1	1	1	1	1	1	1	-

Section II
Limitations

BEECHCRAFT Baron 55, A55
Serial TC-1 thru TC-501

SYSTEM and/or COMPONENT	Number Installed				Remarks and/or Exceptions
	VFR Day	VFR Night	IFR Day	IFR Night	
FUEL EQUIPMENT					
Engine driven fuel pump	2	2	2	2	-
Fuel boost pump	2	2	2	2	-
Fuel quantity indicator	2	2	2	2	-
Fuel quantity indicator selector switch	1	1	1	1	-
Fuel pressure indicator	1	1	1	1	- Dual indicating

ICE AND RAIN PROTECTION							
Alternate static air source	1	-	1	-	1	-	-
Pitot heater	1(2)	-	1	-	1	-	-
LANDING GEAR							
Landing gear motor	1	1	1	1	1	1	-
Landing gear position indication lights	2	2	2	2	2	2	2
Landing gear aural warning horn	1	1	1	1	1	1	1

Section II
Limitations

BEECHCRAFT Baron 55, A55
Serial TC-1 thru TC-501

SYSTEM and/or COMPONENT	Number Installed				Remarks and/or Exceptions
	VFR Day	VFR Night	IFR Day	IFR Night	
LIGHTS					
Cockpit and instrument lights	*	-	*	*	-*Lights must illuminate all instruments and controls.
Taxi light	1	-	-	-	
Landing light	2	*	*	*	-*Per FAR 91
Rotating beacon	1(2)	-	1	1	- Top beacon must be operative
Position light	3	-	3	3	

**BEECHCRAFT Baron 55, A55
Serial TC-1 thru TC-501**

**Section II
Limitations**

NAVIGATION INSTRUMENTS									
Altimeter	1	1	1	1	1	1	1	1	-
Airspeed indicator	1	1	1	1	1	1	1	1	-
Vertical speed	1	-	-	-	-	-	-	-	-
Magnetic compass	1	1	1	1	1	1	1	1	-
Attitude indicator	1	-	-	-	-	-	-	-	-
Turn and slip indicator	1	-	-	-	-	-	-	-	-
Directional gyro	1	-	-	-	-	-	-	-	-
Clock	1	-	-	-	-	-	-	-	-
Transponder	*	*	*	*	*	*	*	*	-*Per FAR 91
Distance measuring equipment	*	*	*	*	*	*	*	*	-*Per FAR 91
Navigation equipment	*	-	-	-	-	-	-	-	-*Per FAR 91
OXYGEN									
Oxygen system	-	*	*	*	*	*	*	*	-*Per FAR 91

**Section II
Limitations**

**BEECHCRAFT Baron 55, A55
Serial TC-1 thru TC-501**

SYSTEM and/or COMPONENT	Number Installed				Remarks and/or Exceptions
	VFR Day		IFR Night		
	VFR Day	IFR Day	IFR Day	IFR Night	
VACUUM					
Instrument air source	2	2	2	2	
Instrument air indicator	1	1	1	1	
Deicing pressure indicator	*	*	*	*	- Dual indicating - *One required with optional sur-face deice installation.
ENGINE INDICATING INSTRUMENTS					
Engine tachometer	1	1	1	1	- Dual indicating
Manifold pressure indicators	1	1	1	1	- Dual indicating
Cylinder head temp gage	2	2	2	2	-

**Section II
Limitations**

**BEEHCRAFT Baron 55, A55
Serial TC-1 thru TC-501**

INTENTIONALLY LEFT BLANK

SECTION III

EMERGENCY PROCEDURES

TABLE OF CONTENTS

<i>SUBJECT</i>	<i>PAGE</i>
Emergency Airspeeds	3-3
One Engine Operation	3-4
Determining Inoperative Engine	3-4
One-Engine Inoperative Procedures	3-4
Engine Failure During Take-Off	3-4
Engine Failure After Lift-off and In Flight	3-5
Air Start	3-6
Engine Fire	3-7
On The Ground	3-7
In Flight	3-8
Emergency Descent	3-8
Glide	3-8
Landing Emergencies	3-9
Gear Up Landing	3-9
One-Engine Inoperative Landing	3-9
One-Engine Inoperative Go-Around	3-10
Systems Emergencies	3-10
One-Engine Inoperative Operation on Crossfeed	3-10
Electrical Smoke or Fire	3-11
Landing Gear Manual Extension	3-12
Landing Gear Retraction After Practice Manual Extension	3-13

TABLE OF CONTENTS (Continued)

<i>SUBJECT</i>	<i>PAGE</i>
Ice Protection	3-13
Electrothermal Propeller Deice System	3-13
Alternate (Emergency) Static Air Source System	3-14
Emergency Exit	3-15
Unlatched Door in Flight	3-15
Simulated One-Engine Inoperative	3-16
Spins	3-16

All airspeeds quoted in this section are indicated airspeeds (IAS) and assume zero instrument error.

EMERGENCY AIRSPEEDS

Air Minimum Control Speed (V_{MCA})	... 78 kts/90 mph
Intentional One Engine Inoperative Speed (V_{SSE}) 84 kts/97 mph
Best Rate-of-Climb Speed One-Engine Inoperative (V_Y) 100 kts/115 mph
Best Angle-of-Climb Speed One-Engine Inoperative (V_X) 91 kts/105 mph
Landing - One Engine Inoperative: Maneuvering to Final	
Approach 107 kts/123 mph (minimum)
Final Approach 90 kts/104 mph (minimum)

Stall warning horn is inoperative when the Battery and Generator switches are turned off.

The following information is presented to enable the pilot to form, in advance, a definite plan of action for coping with the most probable emergency situations which could occur in the operation of the airplane. Where practicable, the emergencies requiring immediate corrective action are treated in check list form for easy reference and familiarization. Other situations, in which more time is usually permitted to decide on and execute a plan of action, are discussed at some length. In order to supply one safe speed for each type of emergency situation, the airspeeds presented were derived at 4880 lbs.

ONE ENGINE OPERATION

Two major factors govern one engine operations; airspeed and directional control. The airplane can be safely maneuvered or trimmed for normal hands-off operation and sustained in this configuration by the operative engine **AS LONG AS SUFFICIENT AIRSPEED IS MAINTAINED.**

DETERMINING INOPERATIVE ENGINE

The following checks will help determine which engine has failed.

1. **DEAD FOOT - DEAD ENGINE.** The rudder pressure required to maintain directional control will be on the side of the good engine.
2. **THROTTLE.** Partially retard the throttle for the engine that is believed to be inoperative; there should be no change in control pressures or in the sound of the engine if the correct throttle has been selected. **AT LOW ALTITUDE AND AIRSPEED THIS CHECK MUST BE ACCOMPLISHED WITH EXTREME CAUTION.**

Do not attempt to determine the inoperative engine by means of the tachometers or the manifold pressure gages. These instruments often indicate near normal readings.

ONE-ENGINE INOPERATIVE PROCEDURES

ENGINE FAILURE DURING TAKE-OFF

1. Throttle - **CLOSED**
2. Braking - **MAXIMUM**

If insufficient runway remains for stopping:

3. Fuel Selector Valves - OFF
4. Battery, Generator and Magneto/Start Switches - OFF

**ENGINE FAILURE AFTER LIFT-OFF
AND IN FLIGHT**

An immediate landing is advisable regardless of take-off weight. Continued flight cannot be assured if take-off weight exceeds the weight determined from the TAKE-OFF WEIGHT graph. Higher take-off weights will result in a loss of altitude while retracting the landing gear and feathering the propeller. Continued flight requires immediate pilot response to the following procedures.

1. Landing Gear and Flaps - UP
2. Throttle (inoperative engine) - CLOSED
3. Propeller (inoperative engine) - FEATHER
4. Power (operative engine) - AS REQUIRED
5. Airspeed - MAINTAIN SPEED AT ENGINE FAILURE (100 KTS (115 MPH) MAX.) UNTIL OBSTACLES ARE CLEARED

After positive control of the airplane is established:

6. Secure inoperative engine:
 - a. Mixture Control - IDLE CUT-OFF
 - b. Fuel Selector - OFF
 - c. Fuel Boost Pump - OFF
 - d. Magneto/Start Switch - OFF
 - e. Generator Switch - OFF
 - f. Cowl Flap - CLOSED

7. Electrical Load - MONITOR (Do not exceed generator capacity)

NOTE

The most important aspect of engine failure is the necessity to maintain lateral and directional control. If airspeed is below 78 kts (90 mph), reduce power on the operative engine as required to maintain control. Refer to the SAFETY INFORMATION Section for additional information regarding pilot technique.

AIR START

CAUTION

The pilot should determine the reason for engine failure before attempting an air start.

1. Fuel Selector Valve - MAIN OR AUXILIARY
2. Throttle - SET approximately 1/4 travel
3. Mixture Control - FULL RICH, below 5000 ft (1/2 travel above 5,000 ft)
4. Fuel Boost Pump - ON (LOW)
5. Magnetos - CHECK ON
6. Propeller:

WITH UNFEATHERING ACCUMULATORS:

- a. Move propeller control full forward to accomplish unfeathering. Use starter momentarily if necessary.
- b. Return control to high pitch (low rpm) position when windmilling starts, to avoid overspeed.

If propeller does not unfeather or engine does not turn, proceed to WITHOUT UNFEATHERING ACCUMULATORS procedure.

WITHOUT UNFEATHERING ACCUMULATORS:

- a. Move propeller control forward of the feathering detent to midrange
 - b. Engage Starter to accomplish unfeathering
 - c. If engine fails to run, clear engine by allowing it to windmill with mixture in IDLE CUT-OFF. When engine fires, advance mixture to FULL RICH
-
7. When Engine Starts - ADJUST THROTTLE, PROPELLER and MIXTURE CONTROLS
 8. Fuel Boost Pump - OFF (when reliable power has been regained)
 9. Generator Switch - ON
 10. Oil Pressure - CHECK
 11. Warm Up Engine (approximately 2000 rpm and 15 in. Hg)
 12. Set power as required and trim

ENGINE FIRE

ON THE GROUND

1. Mixture Controls - IDLE CUT-OFF
2. Continue to crank affected engine
3. Fuel Selector Valves - OFF
4. Battery and Generator Switches - OFF
5. Extinguish with Fire Extinguisher

**Section III
Emergency Procedures**

**BEECHCRAFT Baron 55, A55
Serial TC-1 thru TC-501**

IN FLIGHT

Shut down the affected engine according to the following procedure and land immediately. Follow the applicable single-engine procedures in this section.

1. Fuel Selector Valve - OFF
2. Mixture Control - IDLE CUT-OFF
3. Propeller - FEATHERED
4. Fuel Boost Pump - OFF
5. Magneto/Start Switch - OFF
6. Generator Switch - OFF

EMERGENCY DESCENT

1. Propellers - 2625 RPM
2. Throttles - CLOSED
3. Airspeed - 143 kts (165 mph)
4. Landing Gear - DOWN
5. Flaps - UP

GLIDE

1. Propellers - FEATHER
2. Flaps - UP
3. Landing Gear - UP
4. Cowl Flaps - CLOSED

The glide ratio in this configuration is approximately 2 nautical miles of gliding distance for each 1000 feet of altitude above the terrain at an airspeed of 120 kts (138 mph).

LANDING EMERGENCIES

GEAR-UP LANDING

If possible, choose firm sod or foamed runway. When assured of reaching landing site:

1. Cowl Flaps - CLOSED
2. Wing Flaps - AS DESIRED
3. Throttles - CLOSED
4. Fuel Selector Valves - OFF
5. Mixture Controls - IDLE CUT-OFF
6. Battery, Generator and Magneto Start Switches - OFF
7. Keep wings level during touchdown.
8. Get clear of the airplane as soon as possible after it stops.

NOTE

The gear-up landing procedures are based on the best available information and no actual tests have been conducted.

ONE-ENGINE-INOPERATIVE LANDING

On final approach and when it is certain that the field can be reached:

1. Landing Gear - DOWN
2. Flaps - AS REQUIRED
3. Airspeed - 90 kts/104 mph
4. Power - AS REQUIRED to maintain 800 ft/min rate of descent

When it is certain there is no possibility of go-around:

5. Flaps - DOWN
6. Execute normal landing

ONE-ENGINE-INOPERATIVE GO-AROUND

WARNING

Level flight might not be possible for certain combinations of weight, temperature and altitude. In any event, **DO NOT** attempt a one-engine-inoperative go-around after flaps have been fully extended.

1. Power - **MAXIMUM ALLOWABLE**
2. Landing Gear - **UP**
3. Flaps - **UP**
4. Airspeed - **MAINTAIN 100 kts (115 mph) MINIMUM**

SYSTEMS EMERGENCIES

**ONE-ENGINE-INOPERATIVE OPERATION
ON CROSSFEED**

NOTE

The fuel crossfeed system is to be used only during emergency conditions in level flight only.

Left engine inoperative:

1. Right Fuel Boost Pump - **ON (LOW)**
2. Left Fuel Selector Valve - **MAIN OR AUXILIARY**
3. Right Fuel Selector Valve - **CROSSFEED**
4. Right Fuel Boost Pump - **ON or OFF as required**

Right engine inoperative:

1. Left Fuel Boost Pump - ON (LOW)
2. Right Fuel Selector Valve - MAIN OR AUXILIARY
3. Left Fuel Selector Valve - CROSSFEED
4. Left Fuel Boost Pump - LOW or OFF as required

ELECTRICAL SMOKE OR FIRE

Action to be taken must consider existing conditions and equipment installed:

1. Battery and Generator Switches - OFF

WARNING

Electrically driven flight instruments will become inoperative.

2. Oxygen - AS REQUIRED
3. All Electrical Switches - OFF
4. Battery and Generator Switches - ON
5. Essential Electrical Equipment - ON (Isolate defective equipment)

NOTE

Ensure fire is out and will not be aggravated by draft. Turn off CABIN HEAT switch and push in the CABIN AIR control. Open pilot's storm window, if required.

LANDING GEAR MANUAL EXTENSION

Reduce airspeed before attempting manual extension of the landing gear.

1. LG MOTOR Circuit Breaker - PULL
2. Landing Gear Handle - DOWN
3. Remove cover from handcrank at rear of front seats. Engage handcrank and turn counterclockwise as far as possible (approximately 50 turns). Stow handcrank.
4. Check mechanical indicator to ascertain that gear is down.
5. If electrical system is operative, check landing gear position light and warning horn (check LG RELAY circuit breaker engaged).

CAUTION

The manual extension system is designed only to lower the landing gear; do not attempt to retract the gear manually.

WARNING

Do not operate the landing gear electrically with the handcrank engaged, as damage to the mechanism could occur.

After emergency landing gear extension, do not move any landing gear controls or reset any switches or circuit breakers until airplane is on jacks, as failure may have been in the gear-up circuit and gear might retract with the airplane on the ground.

**LANDING GEAR RETRACTION AFTER
PRACTICE MANUAL EXTENSION**

After practice manual extension of the landing gear, the gear may be retracted electrically, as follows:

1. Handcrank - CHECK, STOWED
2. Landing Gear Motor Circuit Breaker - IN
3. Landing Gear Handle - UP

ICE PROTECTION

***ELECTROTHERMAL PROPELLER DEICE
SYSTEM***

1. Loss of one generator; turn off unnecessary electrical equipment. Turn the prop deice system off while operating the cabin heater blower or the landing gear motor. Monitor electrical loads so as not to exceed generator capacity.

An abnormal reading on the Propeller Deice Ammeter indicates need for the following action:

- a. Zero Amps:

Check prop deice circuit breaker. If the circuit breaker has tripped, a wait of approximately 30 seconds is necessary before resetting. If ammeter reads 0 and the circuit breaker has not tripped or if the ammeter still reads 0 after the circuit breaker has been reset, turn the switch off and consider the prop deice system inoperative.

Section III
Emergency Procedures

BEECHCRAFT Baron 55, A55
Serial TC-1 thru TC-501

b. Zero to 7 Amps:

If the prop deice system ammeter occasionally or regularly indicates less than 7 amps, operation of the prop deice system can continue unless serious propeller imbalance results from irregular ice throw-offs.

c. 12 to 15 Amps:

If the prop deicing system ammeter occasionally or regularly indicates 12 to 15 amps, operation of the prop deice system can continue unless serious propeller imbalance results from irregular ice throw-offs.

d. More than 15 Amps:

If the prop deice system ammeter occasionally or regularly indicates more than 15 amps, the system should not be operated unless the need for prop deicing is urgent.

ALTERNATE (EMERGENCY) STATIC AIR SOURCE SYSTEM

THE EMERGENCY STATIC AIR SOURCE SHOULD BE USED FOR CONDITIONS WHERE THE NORMAL STATIC SOURCE HAS BEEN OBSTRUCTED. When the airplane has been exposed to moisture and/or icing conditions (especially on the ground), the possibility of obstructed static ports should be considered. Partial obstructions will result in the rate of climb indication being sluggish during a climb or descent. Verification of suspected obstruction is possible by switching to the emergency system and noting a sudden sustained change in rate of climb. This may be accompanied by abnormal indicated airspeed and altitude changes beyond normal calibration differences.

Whenever any obstruction exists in the Normal Static Air System or the Emergency Static Air System is desired for use:

1. Emergency Static Air Source - Valve - OPEN (lower sidewall adjacent to pilot).
2. For Airspeed Calibration and Altimeter Corrections, refer to the PERFORMANCE section.

CAUTION

The emergency static air valve should remain in the CLOSED position when system is not needed.

EMERGENCY EXIT

An emergency exit is provided as an openable window on the left side of the airplane as indicated by the emergency exit placard. The cabin door, the optional cargo door and/or the openable window on the right side of the cabin may be used for egress if required. The right openable window operates in the same manner as the emergency exit for egress. To open emergency exit:

1. Unlatch window
2. Pull pin and push window out

UNLATCHED DOOR IN FLIGHT

If the cabin door is not locked it may come unlatched in flight. This may occur during or just after take-off. The door will trail in a position approximately 3 to 4 inches open. Flight characteristics of the airplane will not be affected except for a reduction in performance. Return to the field in a normal manner. If practicable, during the landing flare-out have a passenger hold the door to prevent it from swinging open.

SIMULATED ONE ENGINE INOPERATIVE

ZERO THRUST (Simulated Feather)

Use the following power setting (only on one engine at a time) to establish zero thrust. Use of this power setting avoids the difficulties of restarting an engine and preserves the availability of engine power.

The following procedure should be accomplished by alternating small reductions of propeller and then throttle, until the desired setting has been reached.

1. Propeller Lever - RETARD TO FEATHER DETENT
2. Throttle Lever - SET 12 in. Hg MANIFOLD PRESSURE

NOTE

This setting will approximate Zero Thrust using recommended One-Engine Inoperative Climb speeds.

SPINS

If a spin is entered inadvertently:

Immediately move the control column full forward, apply full rudder opposite to the direction of the spin and reduce power on both engines to idle. These three actions should be done as near simultaneously as possible; then continue to hold this control position until rotation stops and then neutralize all controls and execute a smooth pullout. Ailerons should be neutral during recovery.

NOTE

Federal Aviation Administration Regulations did not require spin demonstration of airplanes of this weight; therefore, no spin tests have been conducted. The recovery technique is based on the best available information.

SECTION IV

NORMAL PROCEDURES

TABLE OF CONTENTS

<i>SUBJECT</i>	<i>PAGE</i>
Airspeeds for Safe Operation	4-3
Preflight Inspection	4-4
Before Starting	4-7
Starting	4-8
After Starting and Taxi	4-10
Before Takeoff	4-10
Takeoff	4-11
Maximum Performance Climb	4-13
Cruise Climb	4-13
Cruise	4-13
Leaning Using EGT	4-14
Descent	4-14
Before Landing	4-15
Balked Landing	4-15
After Landing	4-16
Shutdown	4-16
Oxygen System	4-16
Cold Weather Operation	4-19
Preflight Inspection	4-19
Engines	4-20
External Power	4-21
Starting Engines Using Auxiliary Power Unit	4-22
Taxiing	4-22
June 1982	4-1

TABLE OF CONTENTS

<i>SUBJECT</i>	<i>PAGE</i>
Ice Protection Systems	4-22
Alternate (Emergency) Static Air Source	4-23
Electrothermal Propeller Deice	4-24
Propeller Anti-Ice System (Fluid Flow)	4-24
Pitot Heat and Heated Stall Warning	4-25
Windshield Defogging	4-25
Engine Break-In Information	4-26
Practice Demonstration of V_{MCA}	4-26

All airspeeds quoted in this section are indicated airspeeds (IAS) and assume zero instrument error.

AIRSPEEDS FOR SAFE OPERATION

(Settings established at 4880 lbs.)

Two-Engine Best Angle-of-Climb	84 kts/97 mph
Two-Engine Best Rate-of-Climb	101 kts/116 mph
Single-Engine Best Angle-of-Climb ...	91 kts/105 mph
Single-Engine Best Rate-of-Climb ...	100 kts/115 mph
Air Minimum Control (V_{MCA})	78 kts/90 mph
Intentional One Engine Inoperative (V_{SSE})	84 kts/97 mph
Cruise Climb	123 kts/142 mph
Balked Landing Climb	88 kts/101 mph
Landing Approach	
Flaps DOWN	88 kts/101 mph
Flaps UP	97 kts/112 mph
Turbulent Air Penetration	157 kts/181 mph
Maximum Demonstrated Crosswind	22 kts/25 mph

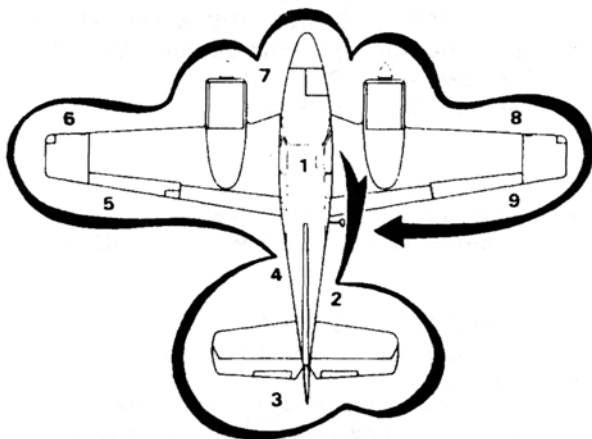

Section IV
Normal Procedures

BEECHCRAFT Baron 55, A55
Serial TC-1 thru TC-501

PREFLIGHT INSPECTION

Emergency Locator Transmitter - ARMED. Location may vary with individual airplanes.

1. COCKPIT:

- a. Control Lock - REMOVE AND STOW
- b. Parking Brake - SET
- c. All Switches - OFF
- d. Trim Tabs - SET TO ZERO

2. RIGHT FUSELAGE:

- a. Load Distribution - CHECK AND SECURED
- b. Baggage Door - SECURE
- c. Static Port - UNOBSTRUCTED

3. EMPENNAGE:

- a. Control Surfaces, Tabs and Deice Boots - CHECK CONDITION, SECURITY, AND ATTACHMENT
- b. Tail Cone, Tail Light, and Beacon - CHECK
- c. Tie Down - REMOVE
- d. Cabin Air Inlet - CHECK

4. LEFT FUSELAGE:

- a. Static Port - UNOBSTRUCTED
- b. All Antennas and Lower Beacon - CHECK

5. LEFT WING TRAILING EDGE:

- a. Fuel Sump Aft of Wheel Well - DRAIN
- b. Fuel Vents - CHECK
- c. Flaps - CHECK GENERAL CONDITION
- d. Aileron - CHECK CONDITION AND FREEDOM OF MOVEMENT, TAB NEUTRAL WHEN AILERON NEUTRAL

6. LEFT WING LEADING EDGE

- a. Lights and Deice Boot - CHECK FOR CONDITION
- b. Stall Warning Vane - CHECK FREEDOM OF MOVEMENT
- c. Fuel - CHECK QUANTITY AND SECURE CAPS
- d. Pitot - REMOVE COVER, EXAMINE FOR OBSTRUCTIONS
- e. Tie Down, Chocks - REMOVE
- f. Engine Oil - CHECK QUANTITY, CAP AND DOOR SECURE
- g. Engine Cowling and Doors - CHECK CONDITION AND SECURITY
- h. Engine Air Intake - EXAMINE FOR OBSTRUCTIONS
- i. Propeller - EXAMINE FOR NICKS, SECURITY AND OIL LEAKS
- j. Cowl Flap - CHECK
- k. Wheel Well Doors, Tire, Brake Line and Shock Strut - CHECK
- l. Landing Gear Uplock Roller - CHECK
- m. Fuel Drains - DRAIN (3)

7. NOSE SECTION

- a. Wheel Well Doors, Tire and Shock Strut - CHECK
- b. Heater Fuel Strainer - DRAIN
- c. Taxi Light - CHECK
- d. Heater Air Inlets - CLEAR
- e. Oxygen - CHECK
- f. Baggage Door - SECURE

Section IV
Normal Procedures

BEECHCRAFT Baron 55, A55
Serial TC-1 thru TC-501

8. RIGHT WING LEADING EDGE

- a. Wheel Well Doors, Tire, Brake Line, and Shock Strut - CHECK
- b. Landing Gear Uplock Roller - CHECK
- c. Cowl Flap - CHECK
- d. Fuel Drains - DRAIN (3)
- e. Engine Oil - CHECK QUANTITY, CAP AND DOOR SECURE
- f. Engine Cowling and Doors - CHECK CONDITION AND SECURITY
- g. Propeller - EXAMINE FOR NICKS, SECURITY AND OIL LEAKS
- h. Engine Air Intake - EXAMINE FOR OBSTRUCTIONS
- i. Fuel - CHECK QUANTITY AND SECURE CAPS
- j. Tie Down and Chocks - REMOVE
- k. Lights and Deice Boot - CHECK FOR CONDITION

9. RIGHT WING TRAILING EDGE

- a. Aileron - CHECK CONDITION AND FREEDOM OF MOVEMENT
- b. Fuel Vents - CHECK
- c. Fuel Sump Aft of Wheel Well - DRAIN
- d. Flaps - CHECK GENERAL CONDITION

NOTE

Check operation of lights if night flight is anticipated.

CAUTION

DO NOT TAXI WITH A FLAT SHOCK STRUT.

BEFORE STARTING

1. Seats - POSITION AND LOCK; Seat Backs - UPRIGHT
2. Rudder Pedals - ADJUST
3. Seat Belts - FASTEN AND ADJUST
Shoulder Harnesses (if installed) - FASTEN AND ADJUST
4. Parking Brake - SET
5. All Avionics - OFF
6. Oxygen - CHECK QUANTITY AND OPERATION
7. Landing Gear Handle - DOWN
8. Cowl Flap Switches - CHECK, OPEN. Check position light - ON (if installed)
9. Fuel Selector Valves - CHECK OPERATION THEN SET TO MAIN
10. All Circuit Breakers, Switches and Equipment Controls - CHECK
11. Battery Switch and Generator Switches - ON (if external power is used, Generator Switches - OFF)
12. Fuel Quantity Indicators - CHECK QUANTITY MAIN AND AUXILIARY. Fuel quantity selector switch to MAIN. (See LIMITATIONS for take-off fuel)
13. Landing Gear Position Lights - CHECK

STARTING

1. Throttle Position - APPROXIMATELY 1/2 IN. OPEN
2. Propeller Control - LOW PITCH (High RPM)
3. Mixture Control - FULL RICH

NOTE

If the engine is hot, and the ambient temperature is 90°F or above, place mixture control in IDLE CUT-OFF, switch fuel boost pump to ON (HIGH) for 30 to 60 seconds, then OFF. Return mixture control to FULL RICH.

4. Fuel Boost Pump - ON (HIGH) (until pressure stabilizes then - OFF)
5. Magneto/Start Switch - START (Observe Starter Limits)

CAUTION

Do not engage starter for more than 30 seconds in any 4-minute period.

NOTE

In the event of a balked start (or overprime condition) place mixture control in IDLE CUT-OFF and open the throttle; operate the starter to remove excess fuel. As engine starts, reduce the throttle to idle rpm and place the mixture control in FULL RICH.

6. Warm-up - 800 to 1200 RPM
7. Oil Pressure - 25 PSI WITHIN 30 SECONDS
8. External Power (if used) - DISCONNECT

WARNING

When using external power, start the right engine first. Disconnect external power before starting left engine.

9. Generator Switch - ON
10. All Engine Indicators - CHECK

CAUTION

If the total of both loadmeters exceeds .2 after two minutes at 1000-1200 rpm, with no additional electrical equipment on, and the indication shows no signs of decreasing, an electrical malfunction is indicated. The battery master and both alternator switches should be placed in the OFF position. Do not take off.

CAUTION

Low voltage, high ammeter or loadmeter readings, dimming of lights, or excessive noise in radio receivers could be indications that problems are developing in the starter system. A noted change in such normal conditions could indicate prolonged starter motor running and the engine should be shut down. No further flight operations should be attempted until the cause is determined and repaired.

11. Using the same procedure, start other engine.

Section IV
Normal Procedures

BEECHCRAFT Baron 55, A55
Serial TC-1 thru TC-501

AFTER STARTING AND TAXI

NOTE

Do not operate engine above 1200 RPM until oil temperature reaches 75°F.

1. Brakes - RELEASE AND CHECK
2. Avionics - ON, AS REQUIRED
3. Exterior Lights - AS REQUIRED

BEFORE TAKE-OFF

1. Seat Belts and Shoulder Harnesses - CHECK
2. Fuel Boost Pumps - OFF (If ambient temperature is 90°F or above, use LOW pressure boost if so equipped)
3. All Instruments - CHECKED
4. Fuel Selector Valves - CHECK (MAIN TANKS)
5. Mixture - FULL RICH (or as required by field elevation)
6. Propellers - EXERCISE AT 2200 RPM

CAUTION

When exercising propellers in their governing range, do not move the control lever aft past the detent. To do so will allow the propeller to change rapidly to the full feathered position, imposing high stresses on the blade shank and engine.

7. Loadmeters - CHECK for proper indication
8. Throttles - 1700 RPM
9. Magnetos - CHECK (Variance between individual magnetos should not exceed 50 rpm, max. drop 150 rpm)
10. Throttles - 1500 RPM

11. Propellers - FEATHERING CHECK (Do not allow an rpm drop of more than 500 rpm)
12. Throttles - IDLE
13. Friction - ADJUST
14. Trim - AS REQUIRED FOR TAKE-OFF
15. Flaps - CHECK AND SET FOR TAKE-OFF
16. Flight Controls - CHECK PROPER DIRECTION, FULL TRAVEL AND FREEDOM OF MOVEMENT
17. Doors and Windows - LOCKED
18. Parking Brake - OFF

TAKE-OFF

Take-Off Power Full throttle, 2625 rpm

Minimum Take-Off Oil Temperature 75°F

1. Power - SET TAKE-OFF POWER (MIXTURE - SET FUEL PRESSURE TO ALTITUDE) BEFORE BRAKE RELEASE
2. Airspeed - ACCELERATE TO AND MAINTAIN RECOMMENDED SPEED
3. Landing Gear - RETRACT (when positive rate of climb is established)
4. Airspeed - ESTABLISH DESIRED CLIMB SPEED (when clear of obstacles)

**Section IV
Normal Procedures**

**BEEHCRAFT Baron 55, A55
Serial TC-1 thru TC-501**

INTENTIONALLY LEFT BLANK

MAXIMUM PERFORMANCE CLIMB

1. Power - SET MAXIMUM CONTINUOUS POWER
2. Mixtures - LEAN TO APPROPRIATE FUEL PRESSURE
3. Cowl Flaps - OPEN
4. Airspeed - ESTABLISH 101 kts/116 mph

CRUISE CLIMB

1. Power - SET (25.0 in. Hg or Full Throttle - 2500 RPM)
2. Mixture Controls - LEAN TO APPROPRIATE FUEL PRESSURE
3. Airspeed - 123 kts/142 mph
4. Cowl Flaps - AS REQUIRED

NOTE

In high ambient temperatures (on airplanes with a two speed boost pump), low pressure boost may be required to prevent excessive fuel flow fluctuations.

CRUISE

Maximum Cruise Power 24.5 in. Hg at 2450 rpm
Recommended Cruise Power . 24.0 in. Hg at 2300 rpm
Recommended Cruise Power . 22.0 in. Hg at 2200 rpm
Economy Cruise Power 20.0 in. Hg at 2100 rpm

1. Power - SET AS DESIRED (Use Tables in PERFORMANCE section)
2. Fuel Flow - LEAN AS REQUIRED
3. Cowl Flaps - AS REQUIRED

LEANING USING THE EXHAUST GAS TEMPERATURE INDICATOR (EGT)

A thermocouple type exhaust gas temperature (EGT) probe is mounted in the system. This probe is connected to an indicator on the instrument panel. The indicator is calibrated in degrees Fahrenheit. Use EGT system to lean the fuel/air mixture when cruising at maximum cruise power or less.

1. Lean the mixture and note the point on the indicator that the temperature peaks and starts to fall.
 - a. CRUISE (LEAN) MIXTURE - Increase the mixture until the EGT shows a drop of 25°F below peak on the rich side of peak.
 - b. BEST POWER MIXTURE - Increase the mixture until the EGT shows a drop of 100°F below peak on the rich side of peak.

CAUTION

Do not continue to lean mixture beyond that necessary to establish peak temperature.

2. Continuous operation is recommended at 25°F or more below peak EGT only on the rich side of peak.
3. Changes in altitude and power settings require the peak EGT to be rechecked and the mixture reset.

DESCENT

1. Altimeter - SET
2. Cowl Flaps - CLOSED
3. Windshield Defroster - AS REQUIRED

4. Power - AS REQUIRED (avoid prolonged idle settings and low cylinder head temperatures)
5. Fuel Selector Valves - MAIN

Recommended descent speeds:

Smooth air 172 kts/198 mph
Rough air (Max.) 157 kts/181 mph

BEFORE LANDING

1. Seat Belts - FASTENED, SEAT BACKS UPRIGHT (Shoulder Harnesses if installed - FASTENED)
2. Fuel Selector Valves - CHECK (MAIN TANKS)
3. Fuel Boost Pumps - OFF, OR LOW AS PER AMBIENT TEMPERATURE
4. Cowl Flaps - AS REQUIRED
5. Mixture Controls - FULL RICH (or as required by field elevation)
6. Landing Gear - DOWN
7. Flaps - DOWN
8. Airspeed - ESTABLISH NORMAL LANDING APPROACH SPEED.
9. Propellers - LOW PITCH (High RPM)

BALKED LANDING

1. Propellers - LOW PITCH (high rpm)
2. Power - MAXIMUM ALLOWABLE
3. Airspeed - BALKED LANDING CLIMB SPEED (88 KTS/101 MPH)
4. Flaps - UP (0°)
5. Landing Gear - UP
6. Cowl Flaps - AS REQUIRED

**Section IV
Normal Procedures**

**BEEHCRAFT Baron 55, A55
Serial TC-1 thru TC-501**

AFTER LANDING

1. Landing and Taxi Lights - AS REQUIRED
2. Flaps - UP
3. Trim Tabs - SET TO ZERO
4. Cowl Flaps - OPEN
5. Fuel Boost Pumps - AS REQUIRED

SHUT DOWN

1. Parking Brake - SET
2. Propellers - LOW PITCH (High RPM)
3. Throttles - 1000 RPM
4. Fuel Boost Pumps - OFF
5. Electrical and Avionics Equipment - OFF
6. Mixture Controls - IDLE CUT-OFF
7. Magneto/Start Switches - OFF, AFTER ENGINES STOP
8. Battery and Generator Switches - OFF
9. Controls - LOCKED
10. If airplane is to be parked for an extended period of time, install wheel chocks and release the parking brake, as greatly varying ambient temperatures may build excessive pressures on the hydraulic system.

OXYGEN SYSTEM

WARNING

NO SMOKING permitted when using oxygen.

PREFLIGHT

1. Open the access door in the lower right hand side of the cabin's aft bulkhead and SLOWLY open the high pressure shut-off valve on the oxygen cylinder.

CAUTION

If the shut-off valve is opened too rapidly, the regulator diaphragm may be ruptured or other damage common to high pressure oxygen systems may occur.

2. Check Oxygen Pressure Gage for pressure reading.
3. Determine percent of full system.
4. Multiply oxygen duration in minutes by percent of full system.

EXAMPLE:

People	5
Gage Pressure	1500 psi
Percent Capacity (from chart)	80%
Cylinder Capacity (full)	48 cu ft
Altitude (planned flight)	15,000 feet
Duration (full cylinder)	120 minutes
Duration (80% full)	96 minutes

**OXYGEN AVAILABLE WITH
PARTIALLY FULL BOTTLE**

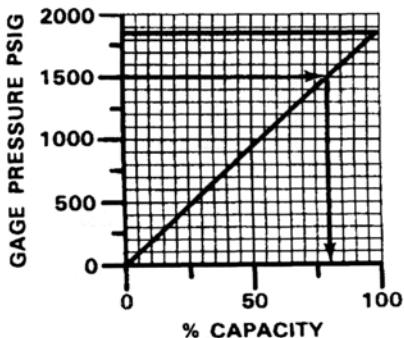

Section IV
Normal Procedures

BEECHCRAFT Baron 55, A55
Serial TC-1 thru TC-501

OXYGEN DURATION

The recommended masks are provided with the system. They are designed to be adjustable to fit the average person, with minimum leakage of oxygen.

CAUTION

Since 90% of the system efficiency is determined by the fit of the oxygen mask, make certain the masks fit properly and are in good condition.

OXYGEN DURATION CHART

Duration in minutes at the following altitudes:

	Persons Using	12,500	15,000	20,000
38 cu ft	1	411	396	360
	2	231	222	204
	3	162	156	144
	4	123	120	114
	5	99	96	90
	6	82	80	74
48 cu ft	1	516	498	456
	2	291	282	258
	3	204	198	180
	4	156	150	138
	5	126	120	114
	6	105	99	97

IN FLIGHT

The use of oxygen is recommended to be in accordance with current FAR operating rules.

1. Insert an oxygen mask plug-in coupling into an oxygen outlet.
2. Check for flow of oxygen into the mask by closing off the opening from the breather bag to the mask, noting that the bag expands. Changes in flow rate will be made automatically with changes in pressure altitude.
3. Adjust the oxygen mask to the face to prevent the escape of oxygen into the cabin.

AFTER USING

1. Close the high pressure shut-off valve.
2. With one or more masks still plugged in, allow the oxygen to drain from the low pressure side of the system.
3. Unplug all masks.

COLD WEATHER OPERATION

PREFLIGHT INSPECTION

In addition to the normal preflight exterior inspection, remove ice, snow and frost from the wings, tail, control surfaces and hinges, propellers, windshield, fuel cell filler caps and fuel vents. If you have no way of removing these formations of ice, snow, and frost leave the airplane on the ground, as these deposits will not blow off. The wing

Section IV
Normal Procedures

BEECHCRAFT Baron 55, A55
Serial TC-1 thru TC-501

contour may be changed by these formations sufficiently that its lift qualities are considerably disturbed and sometimes completely destroyed. Complete your normal preflight procedures. Check the flight controls for complete freedom of movement.

Conditions for accumulating moisture in the fuel tanks are most favorable at low temperatures due to the condensation increase and the moisture that enters as the system is serviced. Therefore, close attention to draining the fuel system will assume particular importance during cold weather.

ENGINES

Use engine oil in accordance with Consumable Materials in the SERVICING section. Always pull the propeller through by hand several times to clear the engine and "limber up" the cold, heavy oil before using the starter. This will also lessen the load on the battery if an auxiliary power unit is not used.

Under very cold conditions, it may be necessary to preheat the engine prior to a start. Particular attention should be applied to the oil cooler, and engine sump to insure proper preheat. A start with congealed oil in the system may produce an indication of normal pressure immediately after the start, but then the oil pressure may decrease when residual oil in the engine is pumped back with the congealed oil in the sump. If an engine heater capable of heating both the engine sump, and cooler is not available, the oil should be drained while the engines are hot and stored in a warm area until the next flight.

If there is no oil pressure within the first 30 seconds of running, or if oil pressure drops after a few minutes of ground operation, shut down and check for broken oil lines, oil cooler leaks or the possibility of congealed oil.

NOTE

It is advisable to use external power for starting in cold weather.

During warm-up, watch engine temperatures closely, since it is quite possible to exceed the cylinder head temperature limit in trying to bring up the oil temperature. Exercise the propellers several times to remove cold oil from the pitch change mechanisms. The propellers should also be cycled occasionally in flight.

During letdown and landing, give special attention to engine temperatures, since the engines will have a tendency toward overcooling.

EXTERNAL POWER

It is very important that the following precautions be observed while using external power.

1. The airplane has a negative ground system. Be sure to connect the positive lead of the auxiliary power unit to the center post of the airplane's external power receptacle and the negative lead of the auxiliary power unit to the other large post.
2. To prevent arcing, make certain no power is being supplied when the connection is made.
3. Make certain that the battery switch is ON, all avionics and electrical switches OFF, and a battery is in the system before connecting an external power unit. This protects the voltage regulators and associated electrical equipment from voltage transients (power fluctuations).

Section IV
Normal Procedures

BEECHCRAFT Baron 55, A55
Serial TC-1 thru TC-501

STARTING ENGINES USING AUXILIARY POWER UNIT

1. Battery switch - ON
2. Generators, Electrical, and Avionics Equipment - OFF
3. Auxiliary Power Unit - CONNECT
4. Auxiliary Power Unit - SET OUTPUT (27.0 to 28.5 volts)
5. Auxiliary Power Unit - ON
6. Right Engine - START (use normal start procedures)
7. Auxiliary Power Unit - OFF (after engine has been started)
8. Auxiliary Power Unit - DISCONNECT (before starting left engine)
9. Generator Switches - ON

TAXIING

Avoid taxiing through water, slush or muddy surfaces if possible. In cold weather, water, slush or mud, when splashed onto landing gear mechanisms or control surface hinges may freeze, preventing free movement and resulting in structural damage.

ICE PROTECTION SYSTEMS

Airplanes are approved for flight into light-to-moderate icing conditions in accordance with operational practices of Bureau of Flight Standards Release No. 434 when the following equipment is installed and operable: Emergency

Static Air Source, Surface Deice System, Propeller Deice or Anti-Ice System, Pitot Heat, Heated Stall Warning, Windshield Defogging or Storm Window, Alternate Induction Air, and External Antenna Mast capable of withstanding ice loads as well as the equipment normally required for IFR flight.

WARNING

Stalling airspeeds should be expected to increase due to the distortion of the wing airfoil when ice has accumulated on the airplane. For the same reason, stall warning devices are not accurate and should not be relied upon. With ice on the airplane, maintain a comfortable margin of airspeed above the normal stall airspeed.

1. ALTERNATE (EMERGENCY) STATIC AIR SOURCE

If the Emergency Static Air Source is desired for use:

- a. Emergency Static Air Source - Valve - OPEN (lower sidewall adjacent to pilot)
- b. For Airspeed Calibration and Altimeter Corrections, refer to PERFORMANCE section

CAUTION

The emergency static air valve should be in the CLOSED position when the system is not needed.

2. ELECTROTHERMAL PROPELLER DEICE

CAUTION

Do not operate the propeller deice when propellers are static.

a. BEFORE TAKEOFF

- (1) Propeller Deice Switch - ON
- (2) Propeller Deice Ammeter - CHECK, 7 to 12 amps

b. IN FLIGHT

- (1) Propeller Deice Switch - ON. The system may be operated continuously in flight and will function automatically until the switch is turned OFF.
- (2) Relieve propeller imbalance due to ice by increasing rpm briefly and returning to the desired setting. Repeat as necessary.

CAUTION

If the propeller deice ammeter indicates abnormal reading, refer to the Emergency Procedures section.

3. PROPELLER ANTI-ICE SYSTEM (FLUID FLOW)

CAUTION

This anti-ice system is designed to PREVENT the formation of ice. Always turn the system ON before entering icing conditions.

a. PREFLIGHT

- (1) Check the quantity in reservoir
- (2) Check slinger ring and lines for obstructions
- (3) Check propeller boots for damage

b. IN FLIGHT

- (1) Prop Anti-ice Switch - ON
- (2) Anti-ice Quantity Indicator - MONITOR

NOTE

See SYSTEM description for endurance.

4. PITOT HEAT AND HEATED STALL WARNING

- a.* Pitot Heat Switch - ON (Note deflection on Load-meter) Heated Stall Warning is activated by the pitot heat switch.

NOTE

Switch may be left on throughout flight. Prolonged operation on the ground could damage the Pitot Heat System.

5. WINDSHIELD DEFOGGING

- a.* Defrost Control - PUSH ON
- b.* Pilot's Storm Window - OPEN, AS REQUIRED

ENGINE BREAK-IN INFORMATION

Refer to Systems section.

PRACTICE DEMONSTRATION OF V_{MCA}

V_{MCA} demonstration may be required for multi-engine pilot certification. The following procedure shall be used at a safe altitude of at least 5000 feet above the ground in clear air only.

WARNING

INFLIGHT ENGINE CUTS BELOW V_{SSE}
SPEED OF 84 KTS/97 MPH ARE PROHIBITED.

1. Landing Gear - Up
2. Flaps - Up
3. Airspeed - Above 84 kts/97 mph (V_{SSE})
4. Propeller Levers - LOW PITCH (High RPM)
5. Throttle (Simulated inoperative engine) - Idle
6. Throttle (Other engine) - Maximum Manifold Pressure
7. Airspeed - Reduce approximately 1 knot per second until either V_{MCA} or stall warning is obtained.

CAUTION

Use rudder to maintain directional control (heading) and ailerons to maintain 5° bank towards the operative engine (lateral attitude). At the first sign of either V_{MCA} or stall warning (which may be evidenced by: inability to maintain heading or lateral attitude, aerodynamic stall buffet, or stall warning horn sound) immediately initiate recovery: reduce power to idle on the operative engine and immediately lower the nose to regain V_{SSE} .

**BEECHCRAFT Baron 55, A55
Serial TC-1 thru TC-501**

SECTION V

PERFORMANCE

TABLE OF CONTENTS

<i>SUBJECT</i>	<i>PAGE</i>
Introduction to Performance and	
Flight Planning	5-3
Conditions	5-3 - 5-13
Comments Pertinent to the Use of	
Performance Graphs	5-14
Performance Graphs	5-15 - 5-47
Airspeed Calibration - Normal System	5-15
Airspeed Calibration - Alternate System	5-16
Altimeter Correction - Normal System	5-17
Altimeter Correction - Alternate System	5-18
Temperature Conversion	5-19
ISA Conversion	5-20
Manifold Pressure vs RPM	5-21
Take-Off Weight	5-22
Stall Speeds - Power Idle	5-23
Wind Components	5-24
Take-Off Distance	5-25
Accelerate - Stop Distance	5-26
Accelerate - Go Distance	5-27
Climb - Two Engine	5-28
Take-Off Climb Gradient, One	
Engine Inoperative	5-29
Time, Fuel, Distance to Climb	5-30
Climb - One Engine Inoperative	5-31
Service Ceiling - One Engine Inoperative	5-32

TABLE OF CONTENTS (Continued)

<i>SUBJECT</i>	<i>PAGE</i>
Cruise Speeds	5-33
Fuel Flow vs Brake Horsepower	5-34
Fuel Flow vs Fuel Pressure	5-35
Cruise Power Settings	5-36-5-39
Maximum Cruise Power	5-36
Recommended Cruise Power	5-37
Recommended Cruise Power	5-38
Economy Cruise Power	5-39
Range Profile - 106 Gallons	5-40
Endurance Profile - 106 Gallons	5-41
Range Profile - 136 Gallons	5-42
Endurance Profile - 136 Gallons	5-43
Holding Time	5-44
Time, Fuel and Distance to Descend	5-45
Climb - Balked Landing	5-46
Landing Distance	5-47

**INTRODUCTION TO PERFORMANCE
AND FLIGHT PLANNING**

All airspeeds quoted in this section are indicated airspeeds (IAS) except as noted and assume zero instrument error.

The graphs and tables in this section present performance information for takeoff, climb, landing and flight planning at various parameters of weight, power, altitude, and temperature. FAA approved performance information is included in this section. Examples are presented on all performance graphs. In addition, the calculations for flight time, block speed, and fuel required are presented using the conditions listed.

CONDITIONS

At Denver:

Outside Air Temperature 15°C (59°F)
Field Elevation 5330 ft
Altimeter Setting 29.60 in. Hg
Wind 270° at 10 kts
Runway 26L length 10,010 ft

Route of Trip

*DEN-V81-AMA

Section V
Performance

BEECHCRAFT Baron 55, A55
Serial TC-1 thru TC-501

For VFR Cruise at 11,500 feet :

ROUTE SEGMENT	MAGNETIC COURSE	DIST NM	WIND 11500 FEET DIR/KTS	OAT 11500 FEET °C	ALT SETTING IN.HG
DEN-COS	161°	55	010/30	-5	29.60
COS-PUB	153°	40	010/30	-5	29.60
PUB-TBE	134°	74	100/20	0	29.56
TBE-DHT	132°	87	200/20	9	29.56
DHT-AMA	125°	65	200/20	10	29.56

*REFERENCE: Enroute Low Altitude Chart L-6

At Amarillo:

Outside Air Temperature 25°C (77°F)
 Field Elevation 3605 ft
 Altimeter Setting 29.56 in. Hg
 Wind 180° at 10 kts
 Runway 21 Length 10,000 ft

To determine pressure altitude at origin and destination airports, add 100 feet to field elevation for each .1 in. Hg below 29.92, and subtract 100 feet from field elevation for each .1 in. Hg above 29.92.

Pressure Altitude at DEN:

$$29.92 - 29.60 = .32 \text{ in. Hg}$$

The pressure altitude at DEN is 320 feet above the field elevation.

$$5330 + 320 = 5650 \text{ ft}$$

**BEECHCRAFT Baron 55, A55
Serial TC-1 thru TC-501**

**Section V
Performance**

Pressure Altitude at AMA:

$$29.92 - 29.56 = .36 \text{ in. Hg}$$

The pressure altitude at AMA is 360 feet above the field elevation.

$$3605 + 360 = 3965 \text{ ft}$$

NOTE

For flight planning, the difference between cruise altitude and cruise pressure altitude has been ignored.

Maximum Allowable Take-off Weight = 4880 lbs

Ramp Weight = 4880 + 21 = 4901 lbs

NOTE

Fuel for start, taxi and take-off is normally 21 pounds.

Enter the Take-Off Weight graph at 5650 feet pressure altitude and 15°C.

The take-off weight to achieve a positive rate-of-climb at lift-off for one engine inoperative is:

Take-off Weight = 4550 pounds

Section V
Performance

BEECHCRAFT Baron 55, A55
Serial TC-1 thru TC-501

Enter the Take-Off Distance graph at 15°C, 5650 feet pressure altitude, 4880 pounds, and 9.5 knots headwind component.

Ground Roll	1925 ft
Total Distance over 50 ft Obstacle	2950 ft
Lift-off Speed	84 kts (97 mph)
50 Foot Speed	91 kts (105 mph)

Enter the Accelerate-Stop graph at 15°C, 5650 feet pressure altitude, 4880 pounds, and 9.5 knots headwind component:

Accelerate-Stop Distance	4030 ft
Engine Failure Speed	84 kts (97 mph)

NOTE

Since 4030 feet is less than the available field length (10,010 ft), the accelerate-stop procedure can be performed at any weight.

Take-off at 4880 lbs can be accomplished. However, if an engine failure occurs before becoming airborne, the accelerate-stop procedure must be performed.

**BEECHCRAFT Baron 55, A55
Serial TC-1 thru TC-501**

**Section V
Performance**

The following example assumes the airplane is loaded so that the take-off weight is 4550 pounds.

Although not required by regulations, information has been presented to determine the take-off weight, field requirements and take-off flight path assuming an engine failure occurs during the take-off procedure. The following illustrates the use of these charts.

Enter the Accelerate-Go graph at 15°C, 5650 feet pressure altitude, 4550 pounds, and 9.5 knots headwind component:

Ground Roll	1800 ft
Total Distance Over 50 ft Obstacle	7100 ft
Lift-off Speed	84 kts (97 mph)
50 Foot Speed	91 kts (105 mph)

Enter the graph for Take-off Climb Gradient - One Engine Inoperative at 15°C, 5650 feet pressure altitude, and 4550 pounds.

Climb Gradient	1.3%
Climb Speed	91 kts (105 mph)

A 1.3% climb gradient is 13 feet of vertical height per 1000 feet of horizontal distance.

NOTE

The Climb Gradient - One Engine Inoperative graph assumes zero wind conditions. Climbing into a headwind will result in higher angles of climb, and hence, better obstacle clearance capabilities.

Section V
Performance

BEEHCRAFT Baron 55, A55
Serial TC-1 thru TC-501

Calculation of horizontal distance to clear an obstacle 90 feet above the runway surface:

Horizontal distance used to climb from 50 feet to 90 feet = $(90-50) (1000 \div 13) = 3077$ feet

Total Distance = $7100 + 3077 = 10,177$ feet

The above results are illustrated below:

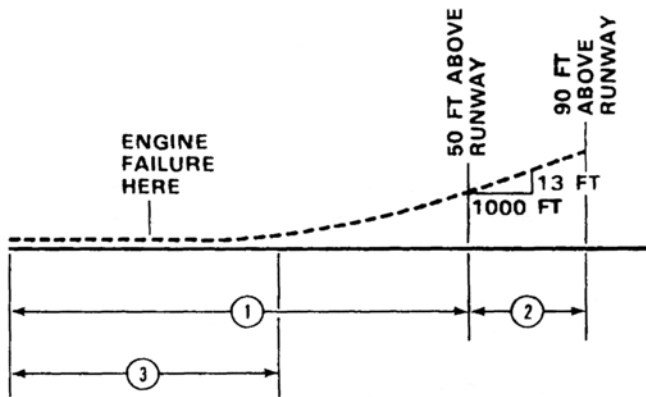

- ① Accelerate-go take-off distance = 7100 feet
- ② Distance to climb from 50 ft. to 90 ft. above runway = 3077 feet
- ③ Accelerate-stop distance for 4880 lbs. take-off weight = 4030 feet

**BEECHCRAFT Baron 55, A55
Serial TC-1 thru TC-501**

**Section V
Performance**

The following calculations provide information for the flight planning procedure. All examples are presented on the performance graphs. A take-off weight of 4880 pounds has been assumed.

Enter the Time, Fuel, and Distance to Climb graph at 15°C to 5650 feet and to 4880 pounds. Also enter at -5°C to 11,500 feet and to 4880 pounds. Read:

Time to Climb = (12.5-5) = 7.5 min
Fuel Used to Climb = (7.3-3) = 4.3 gal
Distance Traveled = (28-10) = 18 NM

The temperatures for cruise are presented for a standard day (ISA); 20°C (36°F) above a standard day (ISA + 20°C); and 20°C (36°F) below a standard day (ISA - 20°C). These should be used for flight planning. The IOAT values are true temperature values which have been adjusted for the compressibility effects. IOAT should be used for setting cruise power while enroute.

Enter the graph for ISA conversion at 11,500 feet and the temperature for the route segment:

DEN-PUB	OAT	=	-5°C
	ISA Condition	=	ISA + 3°C
PUB-TBE	OAT	=	0°C
	ISA Condition	=	ISA + 8°C
TBE-DHT	OAT	=	9°C
	ISA Condition	=	ISA + 17°C
DHT-AMA	OAT	=	10°C
	ISA Condition	=	ISA + 18°C

Section V
Performance

BEECHCRAFT Baron 55, A55
Serial TC-1 thru TC-501

Enter the table for Recommended Cruise Power - 24 in. Hg (or Full Throttle) 2300 rpm at 10,000 ft, 12,000 ft, ISA and ISA + 20°C.

ALTI- TUDE FEET	TEMPERATURE					
	ISA			ISA + 20°C		
	MAN. PRESS. IN. HG	FUEL FLOW GPH/ ENG	TAS KNOTS	MAN. PRESS. IN. HG	FUEL FLOW GPH/ ENG	TAS KNOTS
10000	20.2	10.9	177	20.2	10.6	178
12000	18.7	10.2	174	18.7	10.0	175

Interpolate for 11,500 feet and the temperature for the appropriate route segment. Results of the interpolations are:

ROUTE SEGMENT	MAN. PRESS. IN. HG	FUEL FLOW GPH/ENG	TAS KNOTS
DEN-PUB	19.1	10.4	176
PUB-TBE	19.1	10.3	176
TBE-DHT	19.1	10.2	175
DHT-AMA	19.1	10.2	175

NOTE

The preceding are exact values for the assumed conditions.

**BEECHCRAFT Baron 55, A55
Serial TC-1 thru TC-501**

**Section V
Performance**

Enter the graph for Descent at 11,500 feet to the descent line, and enter again at 3965 feet to the descent line, and read:

Time to Descend = (23-8) = 15 min

Fuel Used to Descend = (7.2-2.4) = 4.8 gal

Descent Distance = (67-22) = 45 NM

Time and fuel used were calculated at Recommended Cruise Power - 24 in. Hg. (or Full Throttle) 2300 RPM as follows:

$$\text{Time} = \frac{\text{Distance}}{\text{Ground Speed}}$$

$$\text{Fuel Used} = (\text{Time}) (\text{Total Fuel Flow})$$

Results are:

ROUTE SEGMENT	DISTANCE NM	EST GROUND SPEED KNOTS	TIME AT CRUISE ALTITUDE HRS: MIN	FUEL USED FOR CRUISE GAL
DEN-COS	*37	204	: 11	3.8
COS-PUB	40	202	: 12	4.1
PUB-TBE	74	160	: 28	9.5
TBE-DHT	87	164	: 32	10.8
DHT-AMA	*20	166	: 07	2.4

*Distance required to climb or descend has been subtracted from segment distance.

**Section V
Performance**

**BEECHCRAFT Baron 55, A55
Serial TC-1 thru TC-501**

TIME - FUEL - DISTANCE

ITEM	TIME HRS: MINS	FUEL GAL	DISTANCE NM
Start, Runup, Taxi and Take- off	0:00	3.3	0
Climb	0:08	4.3	18
Cruise	1:30	30.6	258
Descent	0:15	4.8	45
Total	1:53	43.0	321

Total Flight Time: 1 hour, 53 minutes

Block Speed: $321 \text{ NM} \div 1 \text{ hour, } 53 \text{ minutes} = 170 \text{ knots}$

Reserve Fuel: (45 minutes at Economy Cruise Power):

Enter the cruise power settings table for Economy Cruise Power at 11,500 feet for ISA (assume ISA Fuel Flow Rate).

Fuel Flow Per Engine = 9.0 gal/hr

Total Fuel Flow = 18.0 gal/hr (108 lb/hr)

Reserve Fuel = (45 min) (108 lb/hr) = 81 lbs (13.5 gal)

Total Fuel = $43.0 + 13.5 = 56.5$ gallons

**BEECHCRAFT Baron 55, A55
Serial TC-1 thru TC-501**

**Section V
Performance**

The estimated landing weight is determined by subtracting the fuel required for the flight from the ramp weight:

Assumed ramp weight = 4901 lbs

Estimated fuel from DEN to AMA = 43 gal (258 lbs)

Estimated landing weight = 4901-258 = 4643 lbs

Examples have been provided on the performance graphs. The above conditions have been used throughout. Rate of climb was determined for the initial cruise altitude conditions.

Enter the graph for Landing Distance at 25°C, 3965 feet pressure altitude, 4643 pounds and 9.5 kts headwind component:

Ground Roll 1400 ft
Total Distance over 50 ft Obstacle 2000 ft
Approach Speed 88 kts (101 mph)

Enter the graph for Climb-Balked Landing at 25°C, 3965 feet pressure altitude and 4643 pounds:

Rate-of-Climb 690 ft/min
Climb Gradient 7.8%

**COMMENTS PERTINENT TO THE USE OF
PERFORMANCE GRAPHS**

1. The example, in addition to presenting an answer for a particular set of conditions, also presents the order in which each graph is normally used. For instance, if the first item in the example is OAT, then enter the graph at the known OAT.
2. The reference lines indicate where to begin following guide lines. Always project to the reference line first, then follow the guide lines to the next known item.
3. Indicated airspeeds (IAS) were obtained in flight, by using the Airspeed Calibration-Normal System graph, and the Airspeed Calibration-Normal System Take-off Ground Roll, for all lift-off speeds.
4. The associated conditions define the specific conditions from which performance parameters have been determined. They are not intended to be used as instructions, however, performance values determined from charts can only be achieved if specified conditions exist.
5. The full amount of usable fuel is available for all approved flight conditions.

BEECHCRAFT Baron 55, A55
Serial TC-1 thru TC-501

Section V
Performance

AIRSPED CALIBRATION - NORMAL SYSTEM

EXAMPLE
 IAS - FLAPS
 80 KNOTS
 DOWN
 75 KNOTS
 CAS

NOTE: INDICATED AIRSPEED ASSUMES ZERO INSTRUMENT ERROR

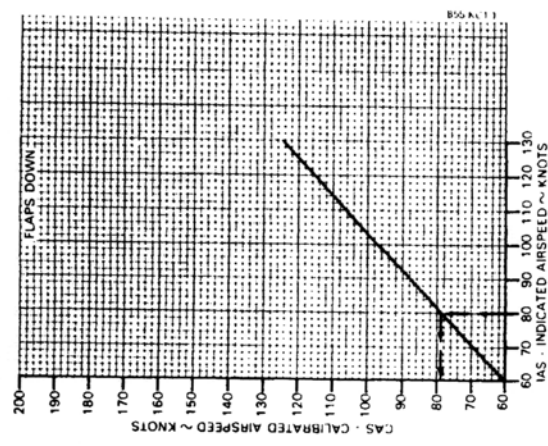
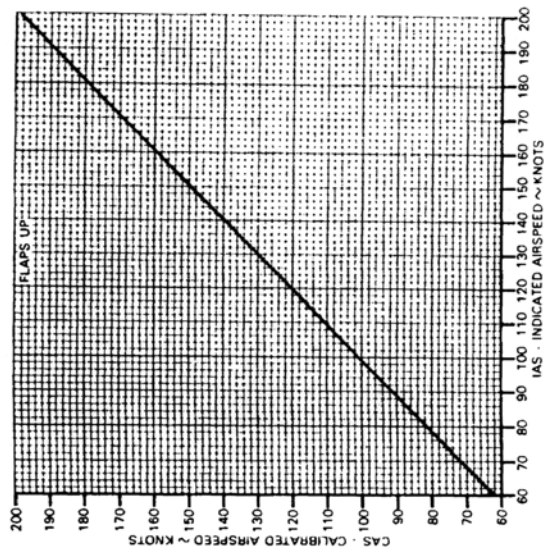

Section V
Performance

BEECHCRAFT Baron 55, A55
Serial TC-1 thru TC-501

AIRSPEED CALIBRATION - ALTERNATE SYSTEM

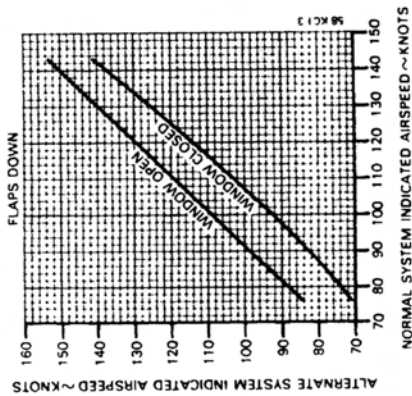
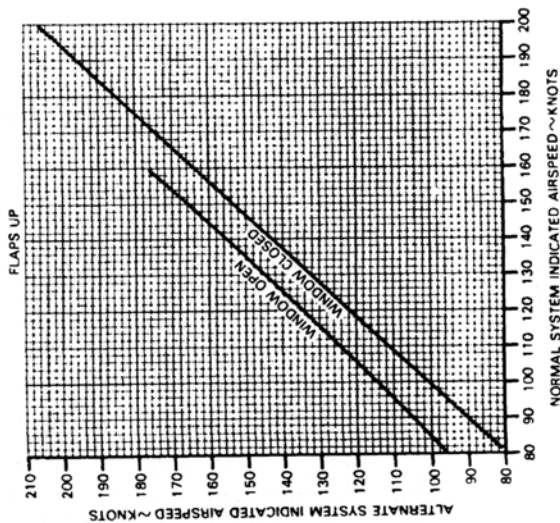

ALTIMETER CORRECTION - NORMAL SYSTEM

NOTE: INDICATED ALTITUDE AND INDICATED AIRSPEED
 ASSUME ZERO INSTRUMENT ERROR

EXAMPLE

IAS 80 KNOTS
 FLAPS DOWN
 INDICATED PRESSURE ALTITUDE 5000 FT
 ALTIMETER CORRECTION -14 FT
 ACTUAL PRESSURE ALTITUDE (5000 - 14) = 4986 FT

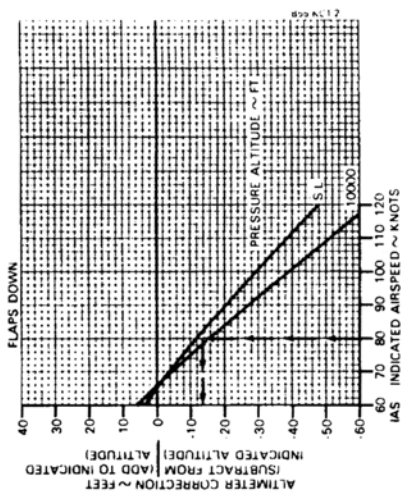
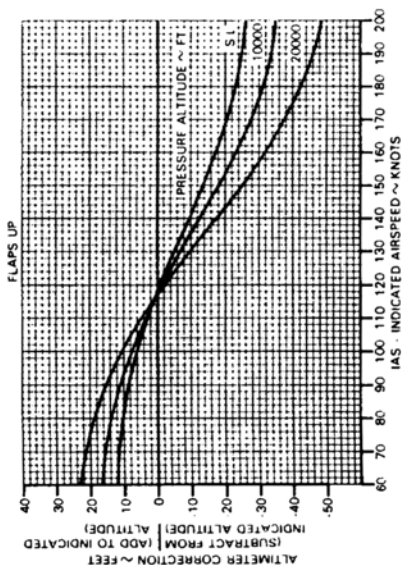

ALTIMETER CORRECTION - ALTERNATE SYSTEM

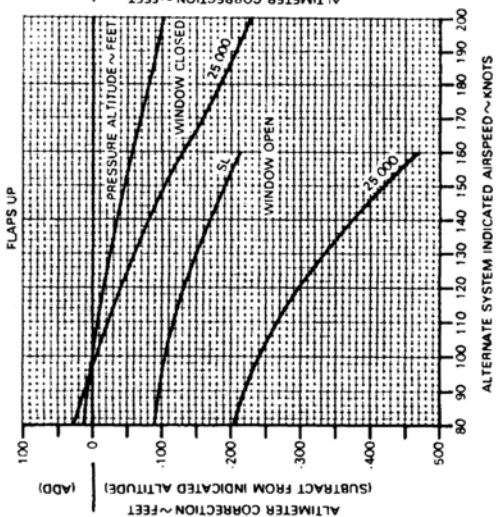
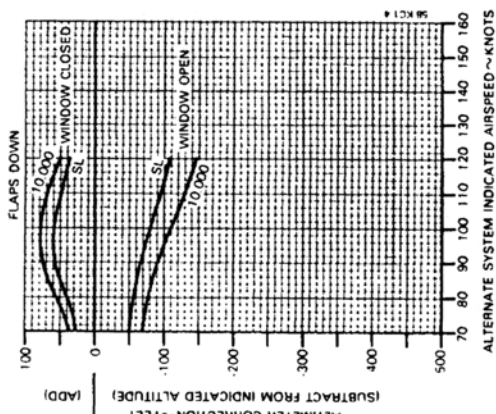

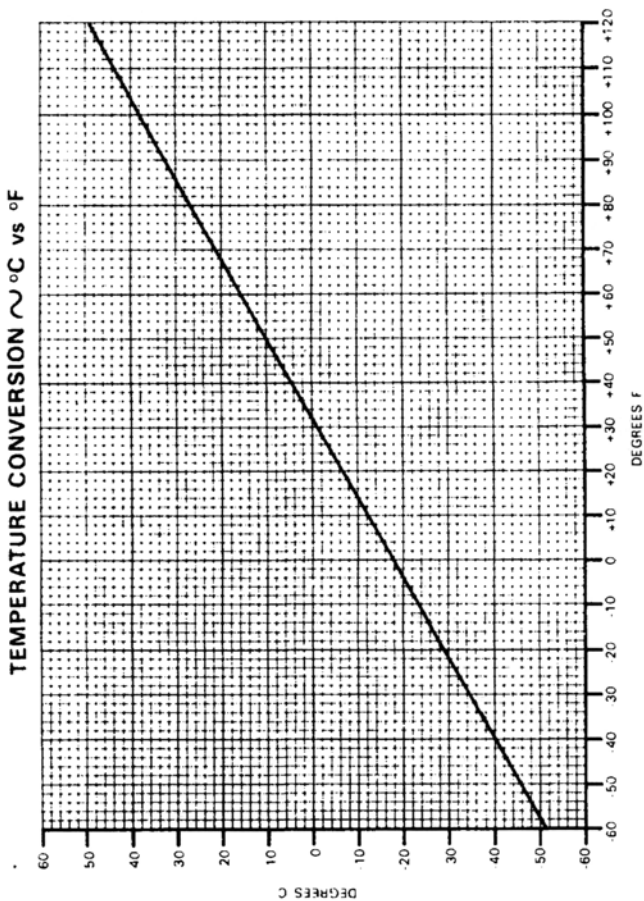

Section V
Performance

BEECHCRAFT Baron 55, A55
Serial TC-1 thru TC-501

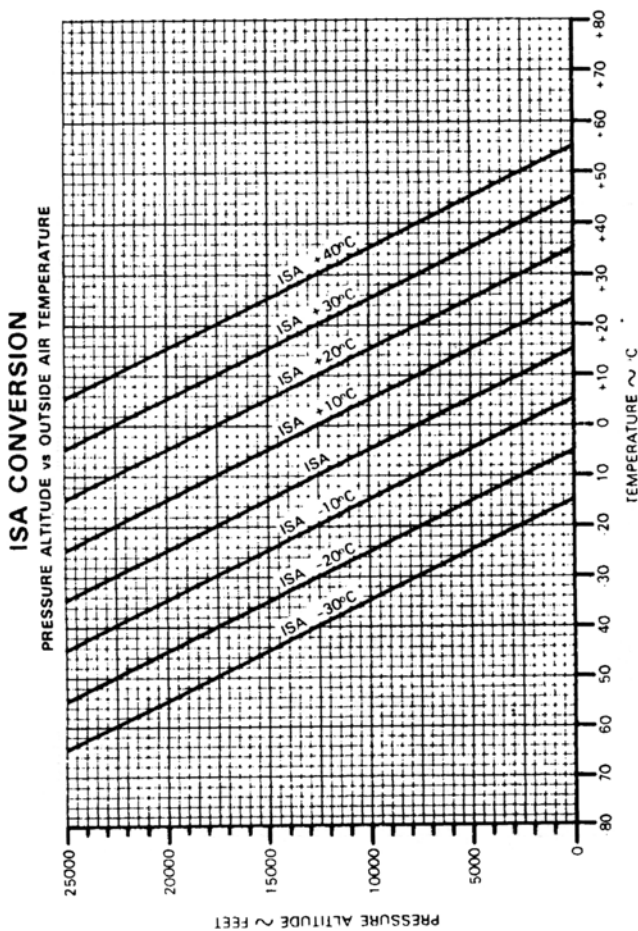

MANIFOLD PRESSURE vs RPM

EXAMPLE
ENGINE SPEED 2300 RPM
MANIFOLD PRESSURE 19.1 IN. HG
WITHIN RECOMMENDED LIMITS

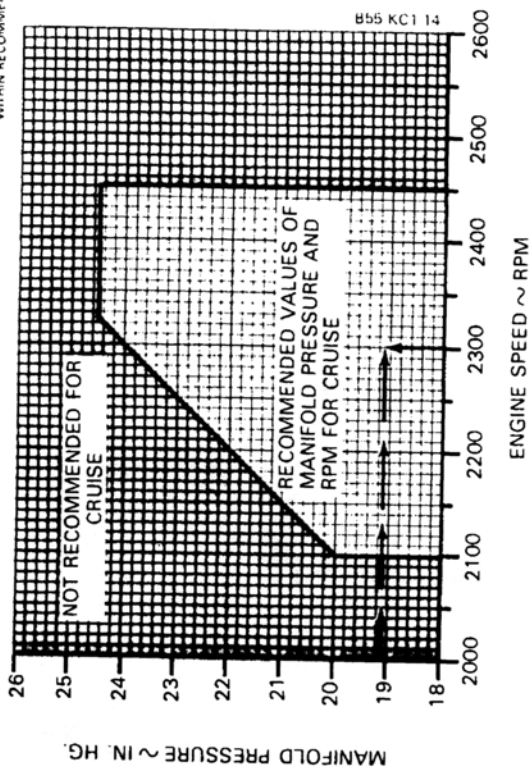

**Section V
Performance**

**BEECHCRAFT Baron 55, A55
Serial TC-1 thru TC-501**

TAKE-OFF WEIGHT

TO ACHIEVE POSITIVE SINGLE ENGINE
RATE-OF-CLIMB AT LIFT-OFF

ASSOCIATED CONDITIONS

AIRPLANE AIRBORNE
POWER FULL THROTTLE AT 2625 RPM
FLAPS UP
LANDING GEAR DOWN
INOPERATIVE PROPELLER FEATHERED

EXAMPLE

PRESSURE ALTITUDE 5650
OAT 15 °C (59°F)
TAKE-OFF WEIGHT 4550 LBS

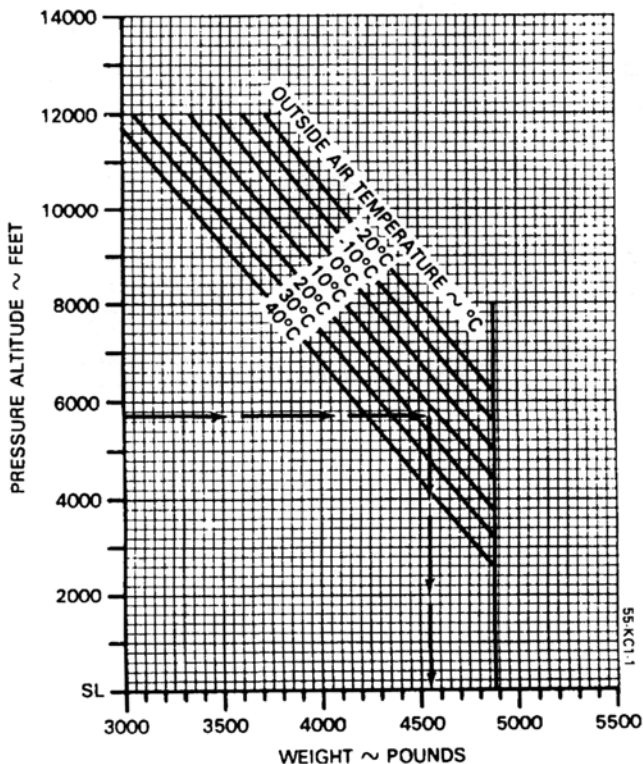

**BEECHCRAFT Baron 55, A55
Serial TC-1 thru TC-501**

**Section V
Performance**

STALL SPEEDS - POWER IDLE

NOTES

- 1 THE MAXIMUM ALTITUDE LOSS EXPERIENCED WHILE CONDUCTING STALLS IN ACCORDANCE WITH CAM 3 120 WAS 350 FEET
- 2 A NORMAL STALL RECOVERY TECHNIQUE MAY BE USED

EXAMPLE

WEIGHT	4550 LBS
FLAPS	UP
ANGLE OF BANK	30°
STALL SPEED	CAS
	IAS
	82 KTS (94 MPH)
	80 KTS (92 MPH)

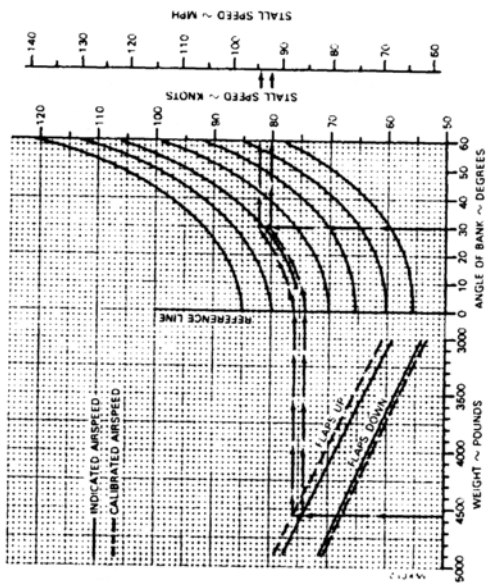

Section V
Performance

BEECHCRAFT Baron 55, A55
Serial TC-1 thru TC-501

WIND COMPONENTS

Demonstrated Crosswind Component is 17 kts

EXAMPLE:

WIND SPEED	20 KTS
ANGLE BETWEEN WIND DIRECTION AND FLIGHT PATH	50°
HEADWIND COMPONENT	13 KTS
CROSSWIND COMPONENT	15 KTS

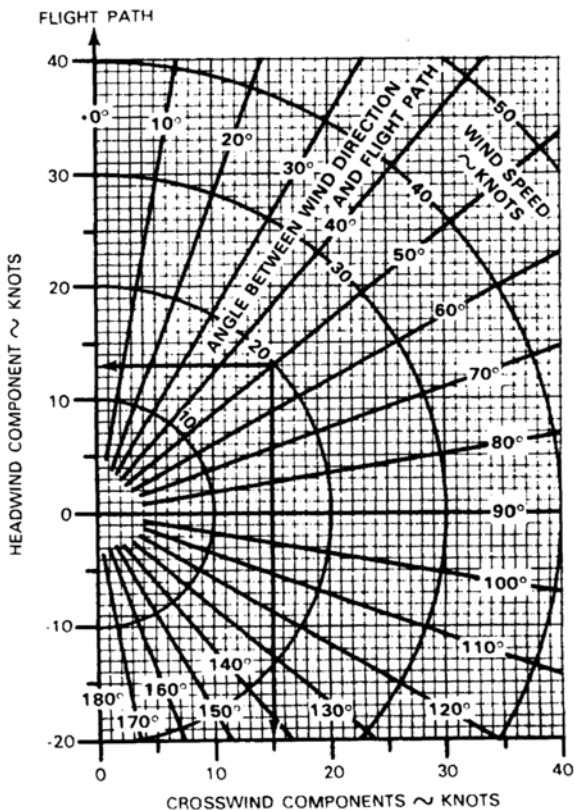

**Section V
Performance**

**BEECHCRAFT Baron 55, A55
Serial TC-1 thru TC-501**

ACCELERATE - STOP DISTANCE

ASSOCIATED CONDITIONS:

- POWER**
1 TAKE-OFF POWER SET BEFORE BRAKE RELEASE
2. ENGINE IDLE AT DECISION SPEED UP
- FLAPS**
RUNWAY PAVED, LEVEL DRY SURFACE
COWL FLAPS OPEN

DECISION SPEED (ALL WEIGHTS)
84 KTS (97 MPH)

EXAMPLE

OAT 15°C (59°F)
PRESSURE ALTITUDE 5500 FT
TAKE OFF WEIGHT 4880 LBS
HEAD WIND 9.5 KTS
ACCELERATE STOP DISTANCE 4030 FT
DECISION SPEED 84 KTS (97 MPH)

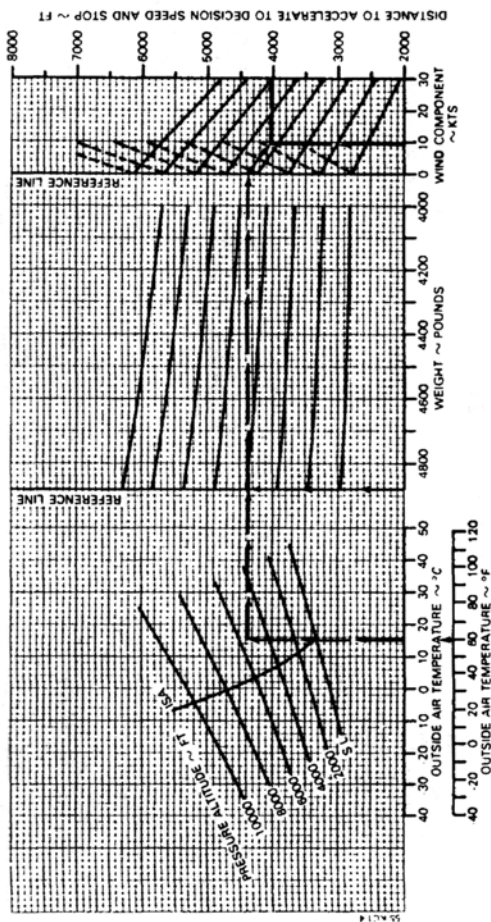

BEECHCRAFT Baron 55, A55
Serial TC-1 thru TC-501

Section V
Performance

ACCELERATE-GO DISTANCE

ASSOCIATED CONDITIONS:

POWER TAKE OFF POWER SET BEFORE BRAKE RELEASE
 FLAPS UPTRACT AFTER LIFT OFF
 LANDING GEAR RETRACTED LEVEL DRY SURFACE
 RUNWAY OPEN
 COWL FLAPS OPEN

EXAMPLE:

OAT 15°C (59°F)
 PRESSURE ALTITUDE 5650 FT
 TAKE OFF WEIGHT 4550 LB
 HEAD WIND COMPONENT 9.5 KTS
 GROUND ROLL TO CLEARANCE OVER 50 FT OBSTACLE 1800 FT
 TO CLEARANCE OVER 7100 FT

TAKE OFF SPEEDS (ALL WEIGHTS):
 84 KNOTS (97 MPH)
 50 FT SPEED (ALL WEIGHTS):
 91 KNOTS (105 MPH)

NOTES:

- 1 DISTANCES ASSUME AN ENGINE FAILURE AT LIFT OFF AND PROPELLER IMMEDIATELY FEATHERED
- 2 WEIGHTS IN SHADED AREA MAY NOT PROVIDE POSITIVE ONE ENGINE INOPERATIVE CLIMB REFER TO TAKE OFF WEIGHT GRAPH FOR MAXIMUM WEIGHT AT WHICH THE ACCELERATE GO PROCEDURE SHOULD BE ATTEMPTED

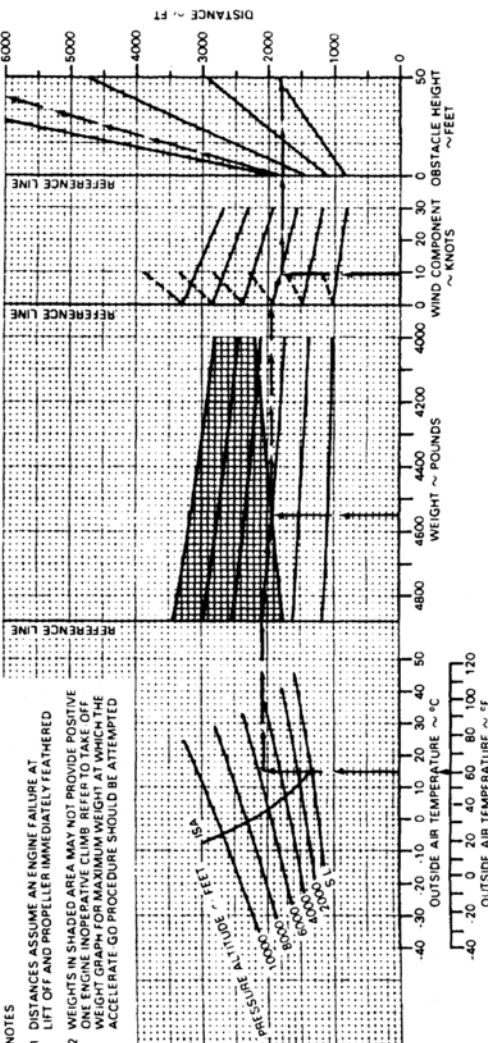

**Section V
Performance**

**BEECHCRAFT Baron 55, A55
Serial TC-1 thru TC-501**

CLIMB-TWO ENGINE

ASSOCIATED CONDITIONS

- POWER MAXIMUM CONTINUOUS AT 2625 RPM
- FLAPS UP
- LANDING GEAR UP
- COXW FLAPS OPEN
- MIXTURE LEAN TO APPROPRIATE
- FUEL PRESSURE

CLIMB SPEED 101 KNOTS (ALL WEIGHTS)
116 MPH

EXAMPLE

OAT 5°C (23°F)
PRESSURE ALTITUDE 1500 FT
WEIGHT 4855 LBS
RATE OF CLIMB 690 FT/MIN
CLIMB GRADIENT 5.5%

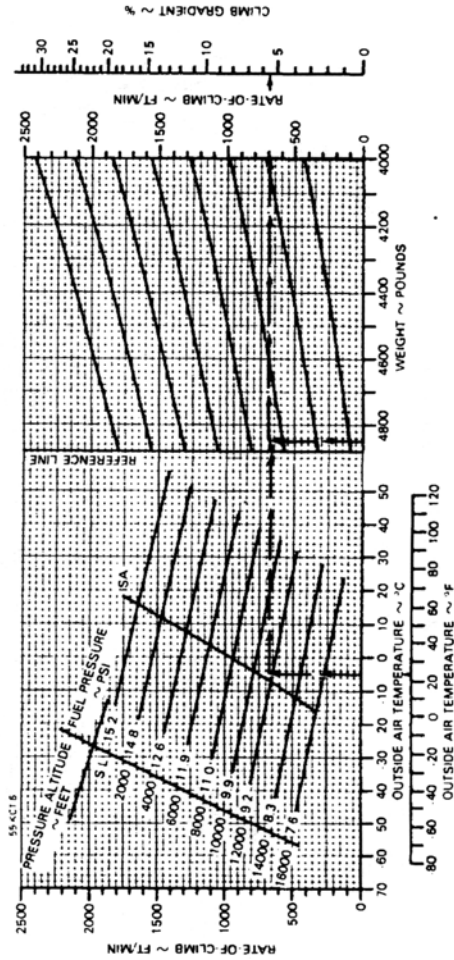

BEECHCRAFT Baron 55, A55
Serial TC-1 thru TC-501

Section V
Performance

TAKE-OFF CLIMB GRADIENT-ONE ENGINE INOPERATIVE

ASSOCIATED CONDITIONS

POWER
 LANDING GEAR UP
 FLAPS UP
 INOPERATIVE
 PROPELLER FEATHERED
 COWL FLAPS OPEN

TAKE OFF AT 2825 RPM

CLIMB SPEED (ALL WEIGHTS)
 91 KNOTS (105 MPH)

EXAMPLE

OAT 15°C (59°F)
 PRESSURE ALTITUDE 5650 FT
 WEIGHT 4550 LBS

GRADIENT OF CLIMB 1.3%
 CLIMB SPEED 91 KTS (105 MPH)

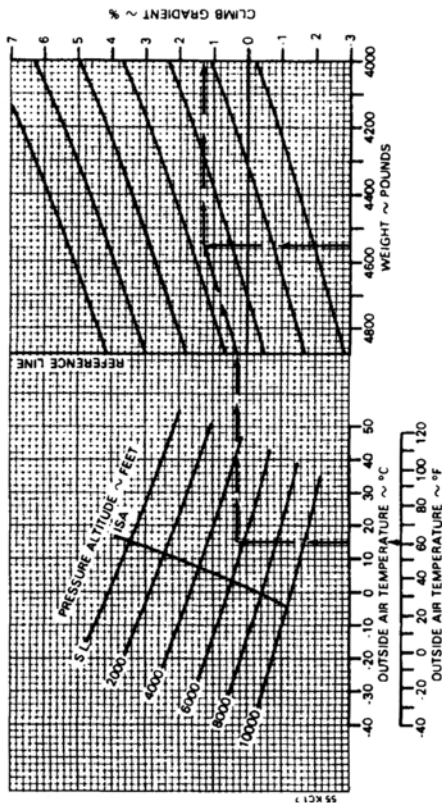

BEECHCRAFT Baron 55, A55
Serial TC-1 thru TC-501

Section V
Performance

CLIMB-ONE ENGINE INOPERATIVE

ASSOCIATED CONDITIONS

- POWER UP
- LANDING GEAR INOPERATIVE
- PROPELLER COMPL. FLAPS MIXTURE
- FEATHERED
- OPEN LEAN TO APPROPRIATE FUEL PRESSURE

MAXIMUM CONTINUOUS AT 2625 RPM

CLIMB SPEED 100 KNOTS (ALL WEIGHTS)
 115 MPH

EXAMPLE

OAT 15°C (59°F)
 PRESSURE ALTITUDE 5650 FT
 WEIGHT 4550 LBS
 RATE-OF-CLIMB 130 FT/MIN
 CLIMB GRADIENT 1.3%

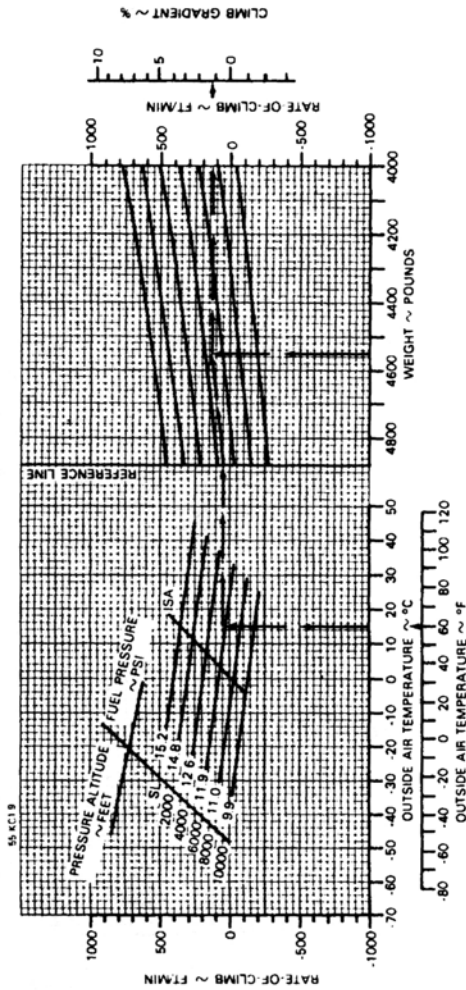

**Section V
Performance**

**BEECHCRAFT Baron 55, A55
Serial TC-1 thru TC-501**

SERVICE CEILING-ONE ENGINE INOPERATIVE

ASSOCIATED CONDITIONS

POWER
LANDING GEAR
INOPERATIVE PROPELLER
FLAPS

MAXIMUM CONTINUOUS
AT 2625 RPM
UP
FEATHERED
UP

EXAMPLE

OAT 5°C (41°F)
WEIGHT 4550 LBS
SERVICE CEILING 8000 FT

NOTE SERVICE CEILING IS THE PRESSURE ALTITUDE WHERE AIRPLANE HAS CAPABILITY OF CLIMBING 50 FT-MINUTE WITH ONE PROPELLER FEATHERED

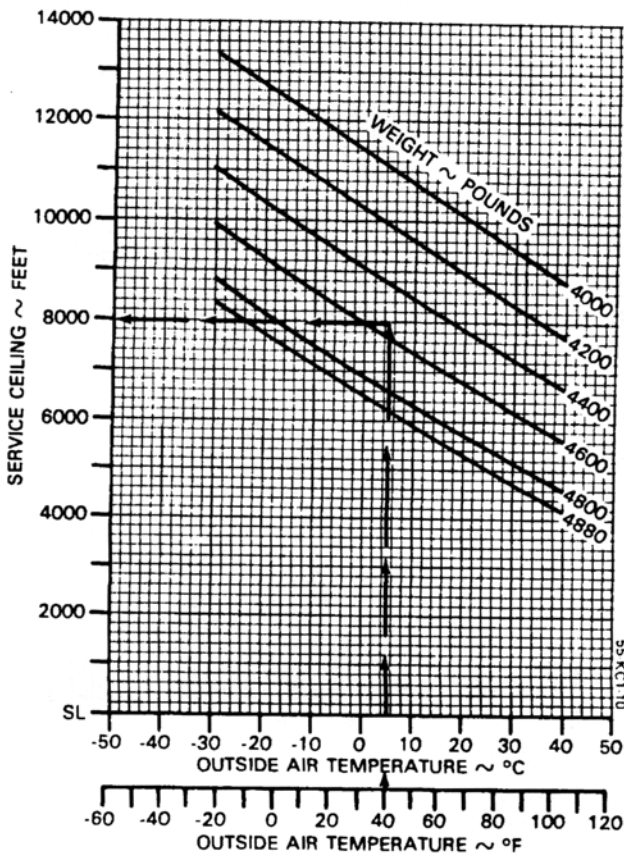

BEECHCRAFT Baron 55, A55
Serial TC-1 thru TC-501

Section V
Performance

CRUISE SPEEDS

ASSOCIATED CONDITIONS

AVERAGE CRUISE WEIGHT 4700 LBS
 TEMPERATURE STANDARD DAY (ISA)

EXAMPLE

PRESSURE ALTITUDE 11500 FT
 POWER SETTING FULL THROTTLE
 2300 RPM
 TRUE AIRSPEED 175 KNOTS

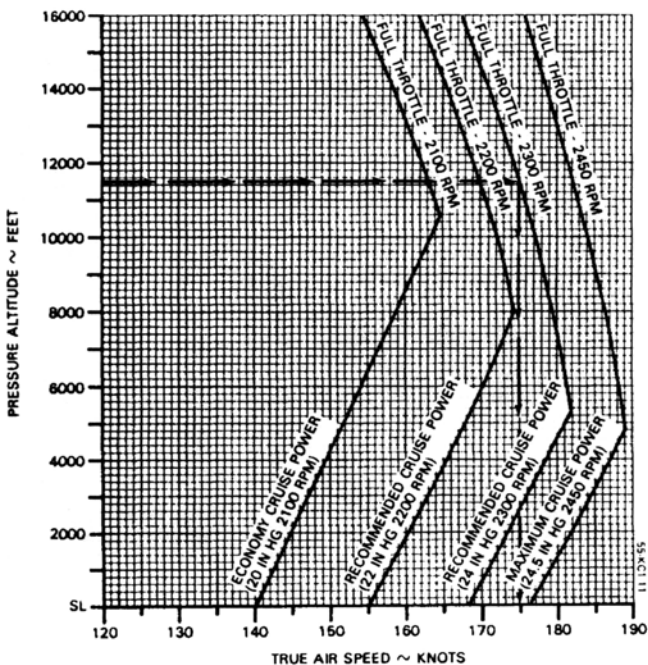

Section V
Performance

BEECHCRAFT Baron 55, A55
Serial TC-1 thru TC-501

FUEL FLOW vs BRAKE HORSEPOWER

EXAMPLE

FUEL FLOW/ENGINE
CONDITION 10.2 GAL/HR
LEVEL FLIGHT
CRUISE LEAN

BRAKE HORSEPOWER
PER ENGINE 144 HP

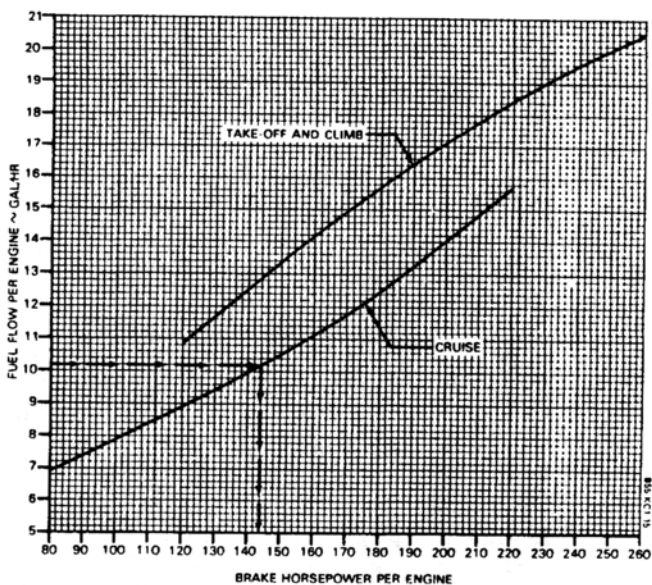

BEECHCRAFT Baron 55, A55
Serial TC-1 thru TC-501

Section V
Performance

FUEL FLOW vs FUEL PRESSURE

EXAMPLE

FUEL FLOW/ENGINE 10.2 GAL/HR

FUEL PRESSURE 5.8 PSI

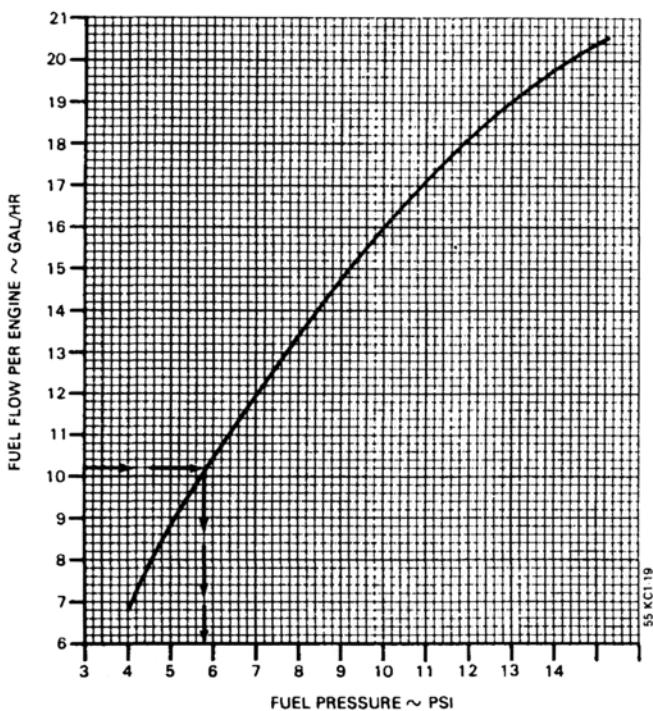

Section V
Performance

BEECHCRAFT Baron 55, A55
Serial TC-1 thru TC-501

CRUISE POWER SETTINGS

MAXIMUM CRUISE POWER
24.5 IN. HG., 2450 RPM (OR FULL THROTTLE)
WEIGHT = 4700 LBS.

PRESS ALT.	FEET	ISA -36°F (-20°C)						STANDARD OAT (ISA)						ISA +36°F (+20°C)										
		OAT		ENGINE SPEED	MAN. PRESS	FUEL FLOW/ ENGINE	TAS	OAT		ENGINE SPEED	MAN. PRESS	FUEL FLOW/ ENGINE	TAS	OAT		ENGINE SPEED	MAN. PRESS	FUEL FLOW/ ENGINE	TAS					
		°F	°C	RPM	IN HG	PSI	GPH	KTS	MPH	°F	°C	RPM	IN HG	PSI	GPH	KTS	MPH	°F	°C	RPM	IN HG	PSI	GPH	KTS
SL	28	-2	2450	24.5	8.6	14.2	175	201	64	18	2450	24.5	8.2	13.7	176	203	100	38	2450	24.5	7.8	13.1	178	205
2000	21	-6	2450	24.5	9.0	14.7	180	207	57	14	2450	24.5	8.6	14.2	182	210	93	34	2450	24.5	8.2	13.7	184	211
4000	14	-10	2450	24.5	9.3	15.2	185	213	51	10	2450	24.5	8.9	14.6	187	215	87	30	2450	24.5	8.4	14.0	189	218
8000	7	-14	2450	23.3	8.9	14.8	188	214	44	6	2450	23.3	8.4	14.0	189	217	80	26	2450	23.3	8.1	13.5	190	219
8000	0	-18	2450	21.8	8.0	13.4	183	213	36	2	2450	21.8	7.8	12.9	187	215	72	22	2450	21.8	7.3	12.4	188	216
10000	-7	-22	2450	20.1	7.2	12.3	183	210	28	-2	2450	20.1	6.8	11.9	185	213	66	18	2450	20.1	6.7	11.5	186	216
12000	-14	-26	2450	18.7	6.5	11.4	180	207	22	-6	2450	18.7	6.4	11.1	182	210	58	14	2450	18.7	6.2	10.8	183	219
14000	-22	-30	2450	17.2	6.1	10.7	178	208	14	-10	2450	17.2	5.9	10.4	179	208	51	10	2450	17.2	5.7	10.1	180	207
16000	-29	-34	2450	15.9	5.7	10.0	176	201	7	-14	2450	16.1	5.6	9.8	176	203	43	6	2450	16.1	5.4	9.5	176	203

NOTES:

- FULL THROTTLE MANIFOLD PRESSURE SETTINGS ARE APPROXIMATE
- SHADED AREA REPRESENTS OPERATION WITH FULL THROTTLE

CRUISE POWER SETTINGS

RECOMMENDED CRUISE
24.0 IN. HG., 2300 RPM (FOR FULL THROTTLE)
WEIGHT = 4700 LBS

PRESS ALT.	ISA -36°F (-20°C)						STANDARD DAY (ISA)						ISA +36°F (+20°C)										
	OAT		ENGINE SPEED	MAN. PRESS	FUEL FLOW/ ENGINE	TAS	OAT		ENGINE SPEED	MAN. PRESS	FUEL FLOW/ ENGINE	TAS	OAT		ENGINE SPEED	MAN. PRESS	FUEL FLOW/ ENGINE	TAS					
	°F	°C					°F	°C					°F	°C					°F	°C			
SL	28	-2	2300	24.0	7.2	12.3	167	192	64	18	2300	24.0	6.9	11.9	169	194	100	38	24.0	6.7	11.6	170	196
2000	21	-6	2300	24.0	7.5	12.7	172	198	57	14	2300	24.0	7.2	12.3	173	199	93	34	24.0	6.9	11.8	175	201
4000	14	-10	2300	24.0	7.8	13.1	177	203	50	10	2300	24.0	7.4	12.6	179	206	86	30	24.0	7.1	12.2	180	207
6000	7	-14	2300	23.4	7.7	13.0	180	207	43	6	2300	23.4	7.3	12.6	187	210	76	26	23.4	7.0	12.1	183	211
8000	0	-18	2300	21.7	7.0	12.0	176	205	36	2	2300	21.7	6.7	11.6	180	207	72	22	21.7	6.6	11.3	181	208
10000	-8	-22	2300	20.2	6.5	11.2	176	203	28	-2	2300	20.2	6.3	10.9	177	203	66	18	20.2	6.1	10.8	178	206
12000	-15	-26	2300	18.7	6.0	10.6	173	199	21	-6	2300	18.7	5.8	10.2	174	201	57	14	18.7	5.7	10.0	176	201
14000	-22	-30	2300	17.3	5.7	9.9	170	196	14	-10	2300	17.3	5.5	9.7	172	198	50	10	17.3	5.3	9.4	172	198
16000	-28	-34	2300	16.0	5.3	9.3	167	192	7	-14	2300	16.0	5.2	9.1	167	192	43	6	16.0	5.1	8.9	167	192

NOTES

1. FULL THROTTLE MANIFOLD PRESSURE SETTINGS ARE APPROXIMATE
2. SHADED AREA REPRESENTS OPERATION WITH FULL THROTTLE

Section V
Performance

BEECHCRAFT Baron 55, A55
Serial TC-1 thru TC-501

CRUISE POWER SETTINGS

RECOMMENDED CRUISE POWER
22.0 IN. HG., 2200 RPM (OR FULL THROTTLE)
WEIGHT = 4700 LBS.

PRESS ALT.	ISA -36°F (-20°C)						STANDARD DAY (ISA)						ISA +36°F (+20°C)											
	OAT		ENGINE SPEED	MAN. PRESS.	FUEL FLOW/ ENGINE	TAS	OAT		ENGINE SPEED	MAN. PRESS.	FUEL FLOW/ ENGINE	TAS	OAT		ENGINE SPEED	MAN. PRESS.	FUEL FLOW/ ENGINE	TAS						
	°F	°C	RPM	IN HG	PSI	GPH	KTS	MPH	°F	°C	RPM	IN HG	PSI	GPH	KTS	MPH	°F	°C	RPM	IN HG	PSI	GPH	KTS	MPH
SL	27	-3	2200	22.0	5.9	10.3	154	177	63	17	2200	22.0	5.7	10.0	155	178	99	37	2200	22.0	5.6	9.8	156	179
2000	20	-7	2200	22.0	6.1	10.6	159	183	56	13	2200	22.0	5.9	10.3	160	184	92	33	2200	22.0	5.7	10.0	161	186
4000	13	-10	2200	22.0	6.3	10.9	164	189	49	10	2200	22.0	6.1	10.6	165	190	85	30	2200	22.0	5.9	10.3	166	191
6000	6	-14	2200	22.0	6.8	11.7	169	194	42	6	2200	22.0	6.2	10.8	170	196	79	26	2200	22.0	6.0	10.5	171	197
8000	-1	-18	2200	21.8	8.5	11.2	173	199	38	2	2200	21.8	6.3	10.9	174	201	72	22	2200	21.8	6.1	10.6	176	203
10000	-8	-22	2200	20.2	6.1	10.8	171	197	28	-2	2200	20.2	5.9	10.3	172	198	64	18	2200	20.2	5.7	10.0	173	198
12000	-15	-26	2200	18.7	5.7	10.0	166	194	21	-6	2200	18.7	5.5	9.7	166	194	57	14	2200	18.7	5.4	9.5	170	196
14000	-22	-30	2200	17.2	5.4	9.4	163	190	14	-10	2200	17.2	5.2	9.1	163	190	50	10	2200	17.2	5.1	8.9	166	193
18000	-30	-34	2200	16.0	5.1	8.9	161	186	6	-14	2200	16.0	4.9	8.7	160	184	42	6	2200	16.0	4.8	8.5	163	186

- NOTES:
1. FULL THROTTLE MANIFOLD PRESSURE SETTINGS ARE APPROXIMATE
2. SHADED AREA REPRESENTS OPERATION WITH FULL THROTTLE

BEECHCRAFT Baron 55, A55
Serial TC-1 thru TC-501

Section V
Performance

CRUISE POWER SETTINGS

ECONOMY CRUISE POWER
 20.0 IN. HG, 2100 RPM (OR FULL THROTTLE)
 WEIGHT = 4700 LBS.

PRESS ALT.	ISA - 36°F (-20°C)						STANDARD DAY (ISA)						ISA +36°F (+20°C)					
	OAT		OAT °C	ENGINE SPEED RPM	MAN. PRESS. IN HG	FUEL FLOW/ ENGINE GPH	TAS KTS/MPH	OAT °C	ENGINE SPEED RPM	MAN. PRESS. IN HG	FUEL FLOW/ ENGINE GPH	TAS KTS/MPH	OAT °C	ENGINE SPEED RPM	MAN. PRESS. IN HG	FUEL FLOW/ ENGINE GPH	TAS KTS/MPH	
	°F	°C																°F
SL	26	-3	2100	20.0	4.9	8.7	139	160	62	17	2100	20.0	4.8	8.5	140	161	63	171
2000	19	-7	2100	20.0	5.1	8.9	144	166	55	13	2100	20.0	4.9	8.7	145	167	51	167
4000	12	-11	2100	20.0	5.2	9.1	149	171	48	9	2100	20.0	5.1	8.9	150	172	44	172
6000	6	-15	2100	20.0	5.3	9.3	153	177	42	5	2100	20.0	5.2	9.1	154	177	38	178
8000	-1	-19	2100	20.0	5.4	9.5	158	182	35	1	2100	20.0	5.3	9.3	159	183	31	183
10000	-8	-22	2100	20.0	5.5	9.7	162	187	28	-2	2100	20.0	5.4	9.4	163	188	24	188
12000	15	58	2100	18.7	5.3	9.3	162	187	21	5	2100	18.7	5.3	9.1	162	187	17	187
14000	23	50	2100	17.3	5.3	9.3	165	182	13	10	2100	17.3	5.3	8.6	165	182	10	182
16000	30	34	2100	16.0	4.8	8.5	165	178	6	14	2100	16.0	4.7	8.3	164	177	42	177

NOTES

1. FULL THROTTLE MANIFOLD PRESSURE SETTINGS ARE APPROXIMATE
2. SHADED AREA REPRESENTS OPERATION WITH FULL THROTTLE

Section V Performance

BEECHCRAFT Baron 55, A55 Serial TC-1 thru TC-501

RANGE PROFILE - 106 GALLONS

STANDARD DAY (ISA)

ASSOCIATED CONDITIONS:

WEIGHT 4700 LBS
AVIATION GASOLINE
FUEL DENSITY 6.0 LB/GAL
INITIAL FUEL LOADING 108 U.S. GAL. (636 LBS)

EXAMPLE

PRESSURE ALTITUDE 11500 FT
POWER SETTING FULL THROTTLE
2300 RPM

RANGE

720 N.M.
829 S.M.

NOTE: RANGE INCLUDES START TAXI CLIMB AND DESCENT
WITH 45 MINUTES RESERVE FUEL AT ECONOMY CRUISE

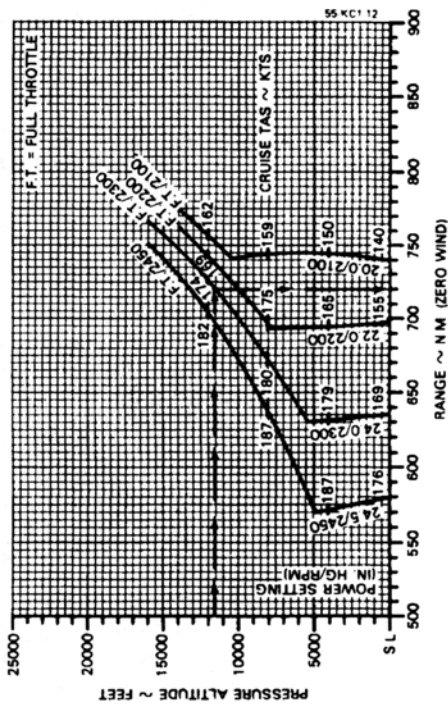

BEECHCRAFT Baron 55, A55 Serial TC-1 thru TC-501

Section V Performance

ENDURANCE PROFILE - 106 GALLONS

ASSOCIATED CONDITIONS

WEIGHT 4700 LBS
FUEL AVIATION GASOLINE
FUEL DENSITY 6.0 LBS/GAL
INITIAL FUEL LOADING 106 U.S. GAL (636 LBS)

STANDARD DAY (ISA)

EXAMPLE
PRESSURE ALTITUDE 11500 FT
POWER SETTING FULL THROTTLE
2300 RPM
ENDURANCE 4.2 HRS
4 HRS 12 MIN

NOTE: ENDURANCE INCLUDES START TAXI CLIMB AND DESCENT WITH 45 MINUTES RESERVE FUEL AT ECONOMY CRUISE

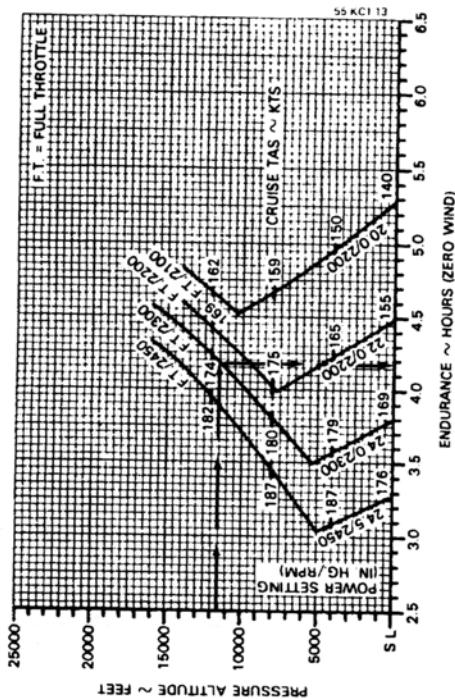

**Section V
Performance**

**BEECHCRAFT Baron 55, A55
Serial TC-1 thru TC-501**

RANGE PROFILE-136 GALLONS

ASSOCIATED CONDITIONS:

4700 LBS
AVIATION GASOLINE
136 LBS FUEL
138 U.S. GAL (816 LBS)
INITIAL FUEL LOADING

STANDARD DAY (ISA)

EXAMPLE

PRESSURE ALTITUDE
POWER SETTING
FULL THROTTLE
2300 RPM

11500 FT
977 N.M
1125 S.M

RANGE

NOTE RANGE INCLUDES START TAXI CLIMB AND
DESCENT WITH 45 MINUTES RESERVE FUEL
AT ECONOMY CRUISE.

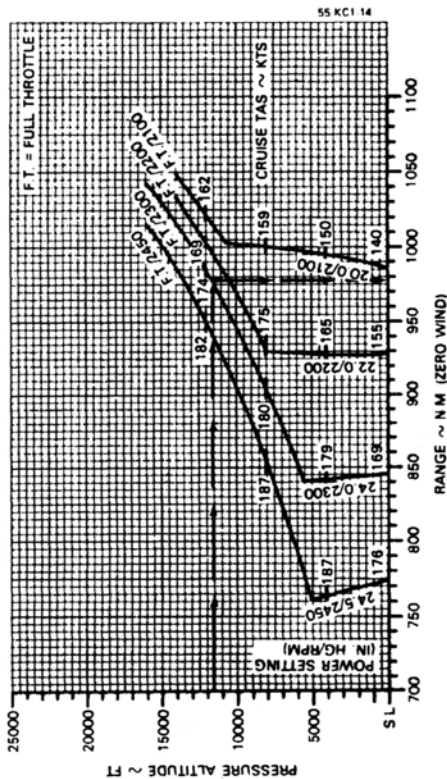

**BEECHCRAFT Baron 55, A55
Serial TC-1 thru TC-501**

**Section V
Performance**

ENDURANCE PROFILE - 136 GALLONS

ASSOCIATED CONDITIONS

4700 LBS
AVIATION GASOLINE
60 LBS GAL
INITIAL FUEL LOADING 136 U.S. GAL (816 LBS)

STANDARD DAY (ISA)

EXAMPLE
PRESSURE ALTITUDE 11500 FT
POWER SETTING FULL THROTTLE
2300 RPM

ENDURANCE
5.6 HRS
5 HRS 36 MIN

NOTE: ENDURANCE INCLUDES START TAXI CLIMB
AND DESCENT WITH 45 MINUTES RESERVE
FUEL AT ECONOMY CRUISE

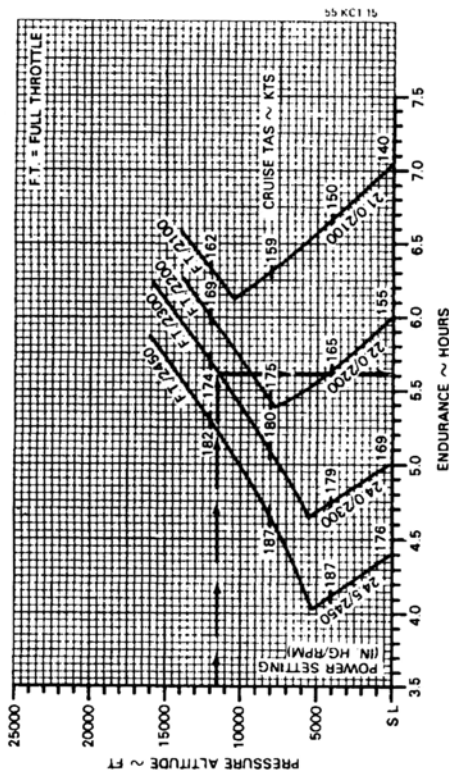

**Section V
Performance**

**BEECHCRAFT Baron 55, A55
Serial TC-1 thru TC-501**

HOLDING TIME

EXAMPLE
 FUEL AVAILABLE FOR HOLDING 200 LBS
 PRESSURE ALT 5000 FT
 HOLDING TIME 1.8 HRS
 1 HR. 48 MIN

ASSOCIATED CONDITIONS:
 POWER SETTING 20.0 IN. HG. OR
 2100 RPM
 2100 RPM

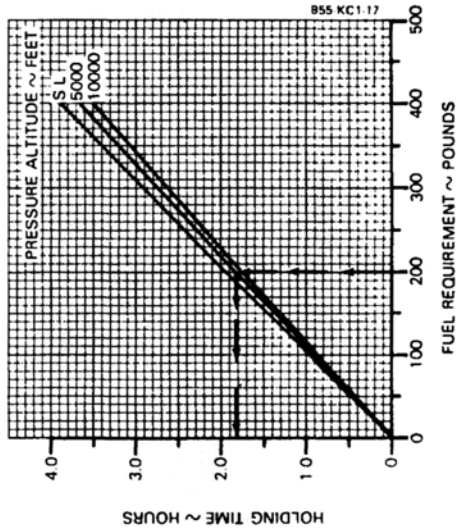

BEECHCRAFT Baron 55, A55
Serial TC-1 thru TC-501

Section V
Performance

TIME, FUEL AND DISTANCE TO DESCEND

ASSOCIATED CONDITIONS

POWER AS REQUIRED TO
 MAINTAIN 500 FT/MIN
 RATE OF DESCENT
 LANDING GEAR UP
 FLAPS UP

EXAMPLE

INITIAL ALTITUDE 11500 FT
 FINAL ALTITUDE 3965 FT
 TIME TO DESCEND (23.8) = 15 MIN
 FUEL TO DESCEND (72.28) = 44 GAL
 DISTANCE TO DESCEND (67.22) = 45 NM

DESCENT SPEED 162 KIAS

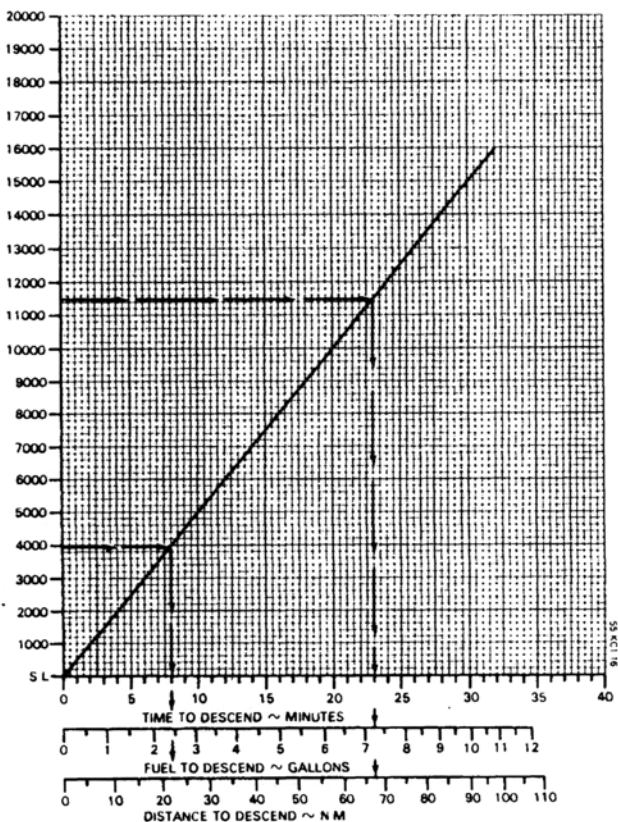

**Section V
Performance**

**BEECHCRAFT Baron 55, A55
Serial TC-1 thru TC-501**

CLIMB-BALKED LANDING

ASSOCIATED CONDITIONS:

- POWERS
- FLAPS
- LANDING GEAR
- MIXTURE
- TAKE-OFF POWER AT 2625 RPM
- CLIMB SPEED (ALL WEIGHTS)
- 88 KTS (101 MPH)
- DOWN
- LEAN TO APPROPRIATE
- FUEL PRESSURE

EXAMPLE

OAT 25°C (77°F)
 PRESSURE ALTITUDE 2865 FT
 WEIGHT 4643 LBS
 RATE OF CLIMB 690 FT/MIN
 CLIMB GRADIENT 7.8%

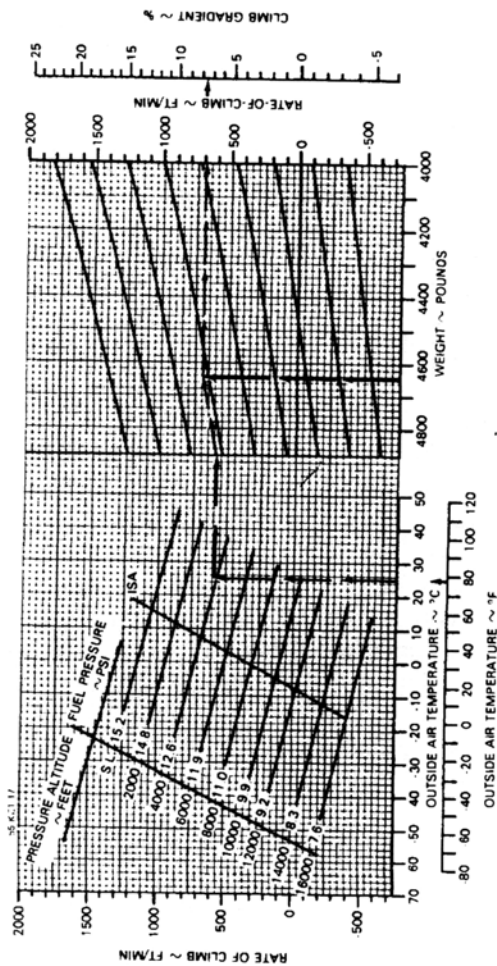

BEECHCRAFT Baron 55, A55
Serial TC-1 thru TC-501

Section V
Performance

LANDING DISTANCE

ASSOCIATED CONDITIONS

- POWER RETAINED TO MAINTAIN 800 FT/MIN ON FINAL APPROACH
- FLAPS DOWN
- LANDING GEAR PAVED, LEVEL, DRY SURFACE
- APPROACH SPEED IAS AS TABULATED
- BRAKING MAXIMUM

EXAMPLE

- OAT 25°C (77°F)
- PRESSURE ALTITUDE 3965 FT
- WEIGHT 4645 LBS
- WIND COMPONENT 9.5 KTS
- GROUND ROLL 1400 FT
- TOTAL OVER 50 FT OBSTACLE 2000 FT
- APPROACH 85 KTS (86 MPH)

WEIGHT POUNDS	SPEED AT 50 FEET	
	KNOTS	MPH
4880	88	101
4800	87	100
4600	85	98
4400	84	97
4200	81	93

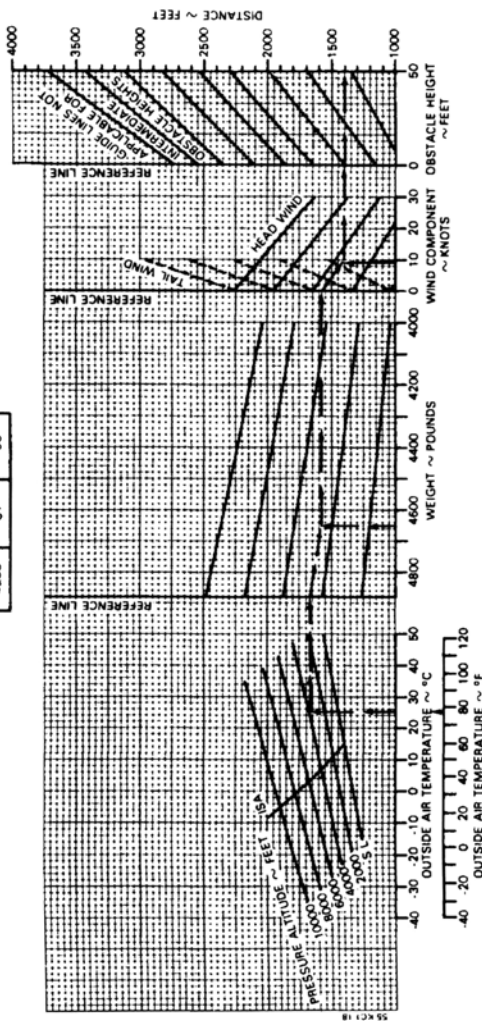

**Section V
Performance**

**BEEHCRAFT Baron 55, A55
Serial TC-1 thru TC-501**

INTENTIONALLY LEFT BLANK

SECTION VI

WEIGHT AND BALANCE/ EQUIPMENT LIST

TABLE OF CONTENTS

<i>SUBJECT</i>	<i>PAGE</i>
Weighing Instructions	6-3
Basic Empty Weight and Balance Form	6-5
Weight and Balance Record	6-7
Loading Instructions	6-9
Seating, Baggage and Equipment	
Arrangements	6-10
Moment Limits vs Weight Table	6-11 - 6-13
Moment Limits vs Weight Graph	6-14
Computing Procedure	6-15
Sample Weight and Balance Loading Form ...	6-17
Weight and Balance Loading Form	6-18
Useful Load Weights and Moments	6-19 - 6-23
Occupants	6-19
Baggage	6-20
Cargo	6-21 - 6-22
Usable Fuel	6-23
Oil	6-23
Airplane Papers (furnished with individual airplane)	

**Section VI
Wt and Bal/Equip List**

**BEEHCRAFT Baron 55, A55
Serial TC-1 thru TC-501**

INTENTIONALLY LEFT BLANK

WEIGHING INSTRUCTIONS

Periodic weighing of the airplane may be required to keep the Basic Empty Weight current. All changes to the airplane affecting weight and balance are the responsibility of the airplane's operator.

1. Three jack points are provided for weighing: two on the wing front spar at Fuselage Station 83.1 and one on the aft fuselage at Fuselage Station 271.0.
2. Fuel should be drained preparatory to weighing. Tanks are drained from the regular drain ports with the airplane in static ground attitude. When tanks are drained, 5.7 pounds of undrainable fuel remain in the airplane at Fuselage Station 81.6. The remainder of the unusable fuel to be added to a drained system is 35.3 pounds at Fuselage Station 78.6
3. Engine oil must be at the full level or completely drained. Total engine oil when full is 45 pounds at Fuselage Station 43.
4. To determine airplane configuration at time of weighing, installed equipment is checked against the airplane equipment list or superseding forms. All installed equipment must be in its proper place during weighing.
5. The airplane must be in a longitudinally level attitude at the time of weighing. Leveling screws are located on the left side of the fuselage at Fuselage Station 152.25 (approximately). Level attitude is determined with a plumb bob.
6. Measurement of the reaction arms for a wheel weighing is made using a steel measuring tape. Measurements are taken, with the airplane level on the scales, from the reference (a plumb bob dropped from the center of either main jack point) to the axle

Section VI
Wt and Bal/Equip List

BEECHCRAFT Baron 55, A55
Serial TC-1 thru TC-501

center line of the main gear and then to the nose wheel axle center line. The main wheel axle center line is best located by stretching a string across from one main wheel to the other. All measurements are to be taken with the tape level with the hangar floor and parallel to the fuselage center line. The locations of the wheel reactions will be approximately at Fuselage Station 96.7 for main wheels and Fuselage Station 12.7 for the nose wheel.

7. Jack point weighings are accomplished by placing scales at the jack points specified in step 1 above. Since the center of gravity of the airplane is forward of Fuselage Station 83.1, the tail reaction of the airplane will be in an up direction. This can be measured on regular scales by placing ballast of approximately 200 pounds on the scales and attached to the aft weighing point by cable of adjustable length. The up reaction will then be total ballast weight minus the scale reading and is entered in the weighing form as a negative quantity.
8. Weighing should always be made in an enclosed area which is free from air currents. The scales used should be properly calibrated and certified.

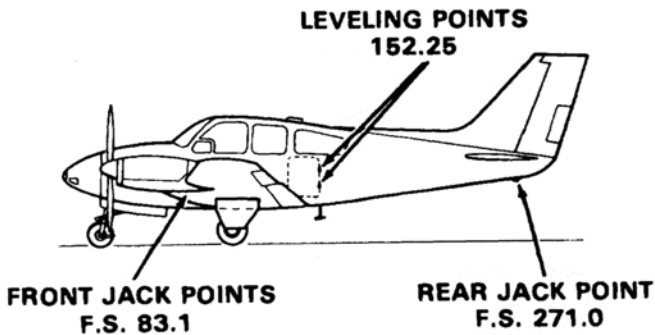

BEECHCRAFT Baron 55, A55
Serial TC-1 thru TC-501

Section VI
Wt and Bal/Equip List

BASIC EMPTY WEIGHT AND BALANCE

BARON SER. NO. _____ REG. NO. _____ DATE _____
STRUT POSITION - NOSE MAIN JACK POINT LOCATION PREPARED BY
 EXTENDED 11.8 96 FORWARD 83.1 Company _____
 COMPRESSED 13.1 97 AFT 271.0 Signature _____

REACTION WHEEL - JACK POINTS	SCALE READING	TARE	NET WEIGHT	ARM	MOMENT
LEFT MAIN					
RIGHT MAIN					
NOSE OR TAIL					
TOTAL (AS WEIGHED)					
Space below provided for additions and subtractions to as weighed condition					
EMPTY WEIGHT (DRY)			45	-	1935
ENGINE OIL			41	79	3239
UNUSABLE FUEL					
BASIC EMPTY WEIGHT					

June 1982

6-5

NOTE

Each new airplane is delivered with a completed sample loading, empty weight and center of gravity, and equipment list, all pertinent to that specific airplane. It is the owner's responsibility to ensure that changes in equipment are reflected in a new weight and balance and in an addendum to the equipment list. There are many ways of doing this; it is suggested that a running tally of equipment changes and their effect on empty weight and c.g. is a suitable means for meeting both requirements.

The current equipment list and empty weight and c.g. information must be retained with the airplane when it changes ownership. Beech Aircraft Corporation cannot maintain this information; the current status is known only to the owner. If these papers become lost, the FAA will require that the airplane be re-weighed to establish the empty weight and c.g. and that an inventory of installed equipment be conducted to create a new equipment list.

LOADING INSTRUCTIONS

It is the responsibility of the airplane operator to ensure that the airplane is properly loaded. At the time of delivery, Beech Aircraft Corporation provides the necessary weight and balance data to compute individual loadings. All subsequent changes in airplane weight and balance are the responsibility of the airplane owner and/or operator.

The empty weight and moment of the airplane at the time of delivery are shown on the airplane Empty Weight and Balance form. Useful load items which may be loaded into the airplane are shown on the Useful Load Weight and Moment tables. The minimum and maximum moments are indicated on the Moment Limits vs Weight table. These moments correspond to the forward and aft center of gravity flight limits for a particular weight. All moments are divided by 100 to simplify computations.

SEATING, BAGGAGE AND EQUIPMENT
ARRANGEMENTS

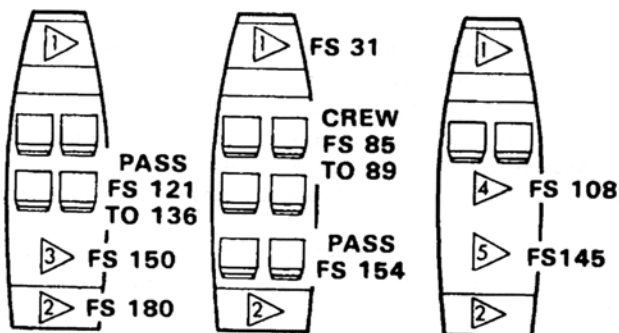

NOTE

The floor structure load limit is 100 pounds per square foot, except for the area between the front and rear spars, where the floor structure load limit is 50 pounds per square foot.

1. MAXIMUM WEIGHT 270 POUNDS INCLUDING EQUIPMENT AND BAGGAGE.
2. MAXIMUM WEIGHT 120 POUNDS INCLUDING EQUIPMENT AND BAGGAGE.
3. MAXIMUM WEIGHT 400 POUNDS INCLUDING EQUIPMENT AND BAGGAGE WITH 5th and 6th SEATS REMOVED OR STOWED.
4. MAXIMUM WEIGHT 200 POUNDS FORWARD OF REAR SPAR INCLUDING EQUIPMENT AND CARGO WITH 3rd and 4th SEATS REMOVED.
5. MAXIMUM WEIGHT 400 POUNDS AFT OF REAR SPAR INCLUDING EQUIPMENT AND CARGO WITH 3rd, 4th, 5th and 6th SEATS REMOVED.

ALL CARGO MUST BE SECURED WITH APPROVED CARGO RETENTION SYSTEMS.

*Refer to PLACARDS in LIMITATIONS Section.

MOMENT LIMITS vs WEIGHT

Moment limits are based on the following weight and center of gravity limit data (landing gear down).

WEIGHT CONDITION	FORWARD CG LIMIT	AFT CG LIMIT
4880 lb. (max.take-off or landing)	79.4	86.0
3800 lb. or less	74.0	86.0
Weight	<u>Minimum Moment</u> 100	<u>Maximum Moment</u> 100
3200	2368	2752
3225	2387	2774
3250	2405	2795
3275	2424	2817
3300	2442	2838
3325	2461	2860
3350	2479	2881
3375	2498	2903
3400	2516	2924
3425	2535	2946
3450	2553	2967
3475	2572	2989
3500	2590	3010
3525	2609	3032
3550	2627	3053
3575	2646	3075

MOMENT LIMITS vs WEIGHT (Continued)

Weight	<u>Minimum Moment</u> 100	<u>Maximum Moment</u> 100
3600	2664	3096
3625	2683	3118
3650	2701	3139
3675	2720	3161
3700	2738	3182
3725	2757	3204
3750	2775	3225
3775	2794	3247
3800	2812	3268
3825	2836	3290
3850	2859	3311
3875	2882	3333
3900	2906	3354
3925	2929	3376
3950	2953	3397
3975	2976	3419
4000	3000	3440
4025	3024	3462
4050	3048	3483
4075	3072	3505
4100	3096	3526
4125	3120	3548
4150	3144	3569
4175	3168	3591
4200	3192	3612
4225	3216	3634
4250	3241	3655
4275	3265	3677

MOMENT LIMITS vs WEIGHT (Continued)

Weight	<u>Minimum</u> <u>Moment</u> 100	<u>Maximum</u> <u>Moment</u> 100
4300	3290	3698
4325	3314	3720
4350	3339	3741
4375	3363	3763
4400	3388	3784
4425	3413	3806
4450	3438	3827
4475	3463	3849
4500	3488	3870
4525	3513	3892
4550	3538	3913
4575	3563	3935
4600	3588	3956
4625	3613	3978
4650	3639	3999
4675	3664	4021
4700	3690	4042
4725	3715	4064
4750	3741	4085
4775	3766	4107
4800	3792	4128
4825	3818	4150
4850	3844	4171
4875	3870	4193
4880	3875	4197

Section VI
Wt and Bal/Equip List

BEECHCRAFT Baron 55, A55
Serial TC-1 thru TC-501

Baron 55 and A55
MOMENT LIMITS vs WEIGHT

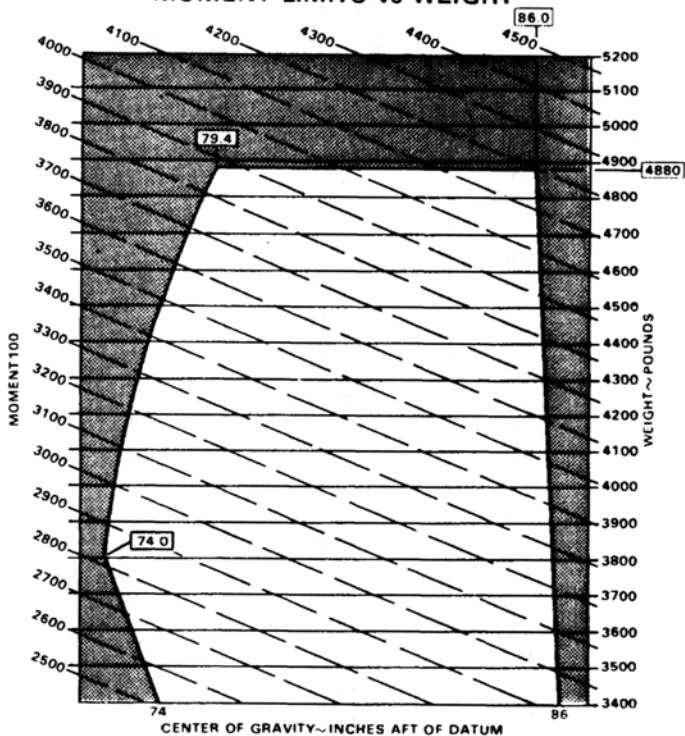

ENVELOPE BASED ON THE FOLLOWING WEIGHT AND
CENTER OF GRAVITY LIMIT DATA (LANDING GEAR DOWN)

WEIGHT CONDITION	FORWARD CG. LIMIT	AFT CG. LIMIT
4880 LB (MAX TAKE-OFF OR LANDING)	79.4	86.0
3800 LB or LESS	74.0	86.0

COMPUTING PROCEDURE

1. Record the *Basic Empty Weight and Moment from the Basic Empty Weight and Balance form (or from the latest superseding form) under the Basic Empty Condition block. The moment must be divided by 100 to correspond to Useful Load Weights and Moments tables.
2. Record the weight and corresponding moment from the appropriate table of each of the useful load items (except fuel) to be carried in the airplane.
3. Total the weight column and moment column. The SUB-TOTAL is the Zero Fuel Condition.
4. Determine the weight and corresponding moment for the fuel loading to be used. This fuel loading includes fuel for the flight, plus that required for start, taxi, and take-off. Add the Fuel to Zero Fuel Condition to obtain the SUB-TOTAL Ramp Condition.
5. Subtract the fuel to be used for start and taxi to arrive at the SUB-TOTAL Take-off Condition.
6. Subtract the weight and moment of the fuel in the incremental sequence in which it is to be used from the take-off weight and moment. The Zero Fuel Condition, the Take-Off Condition, and the Landing Condition moment must be within the minimum and maximum moments shown on the Moment Limit vs Weight table for that weight. If the total moment is less than the

Section VI
Wt and Bal/Equip List

BEECHCRAFT Baron 55, A55
Serial TC-1 thru TC-501

minimum moment allowed, useful load items must be shifted aft or forward load items reduced. If the total moment is greater than the maximum moment allowed, useful load items must be shifted forward or aft load items reduced. If the quantity or location of load items is changed, the calculations must be revised and the moments rechecked.

- * The Empty Weight (Dry) for the airplane may be converted to Basic Empty Weight by adding the weight and moment for full oil (45 lbs. and 1935 lb. in.) and unusable fuel (41 lbs. and 3239 lb. in.).

The following Sample Loading chart is presented to depict the sample method of computing a load. Weights used DO NOT reflect an actual airplane loading.

BEECHCRAFT Baron 55, A55
Serial TC-1 thru TC-501

Section VI
Wt and Bal/Equip List

WEIGHT AND BALANCE LOADING FORM

BARON 55 DATE _____
SERIAL NO. TC-XXXX REG NO. NXXX

ITEM	WEIGHT	MOM/100
1. BASIC EMPTY CONDITION	3277	2531
2. FRONT SEAT OCCUPANTS	340	290
3. 3rd and 4th SEAT OCCUPANTS	340	412
4. 5th and 6th SEAT OCCUPANTS	-	-
5. NOSE BAGGAGE	-	-
6. REAR BAGGAGE	128	192
7. AFT BAGGAGE	-	-
8. CARGO	-	-
9. SUB TOTAL ZERO FUEL CONDITION	4085	3425
10. FUEL - MAIN (74 GAL) FUEL - AUX (62 GAL)	444 372	333 346
11. SUB TOTAL RAMP CONDITION	4901	4104
12. *LESS FUEL FOR START, TAXI, AND TAKE-OFF	-21	-16
13. SUB TOTAL TAKE-OFF CONDITION	4880	4088
14. LESS FUEL - MAIN (20 GAL)	-120	-90
15. SUB TOTAL	4760	3998
16. LESS FUEL - AUX (62 GAL)	-372	-346
17. SUB TOTAL	4388	3652
18. LESS FUEL - MAIN (30 GAL)	-180	-135
19. LANDING CONDITION	4208	3517

*Fuel for start, taxi and take-off is normally 21 lbs at an average mom/100 of 16.

June 1982

6-17

Section VI
Wt and Bal/Equip List

BEEHCRAFT Baron 55, A55
Serial TC-1 thru TC-501

WEIGHT AND BALANCE LOADING FORM

BARON _____ DATE _____

SERIAL NO. _____ REG NO. NXXX

ITEM	WEIGHT	MOM/100
1. BASIC EMPTY CONDITION		
2. FRONT SEAT OCCUPANTS		
3. 3rd and 4th SEAT OCCUPANTS		
4. 5th and 6th SEAT OCCUPANTS		
5. NOSE BAGGAGE		
6. REAR BAGGAGE		
7. AFT BAGGAGE		
8. CARGO		
9. SUB TOTAL ZERO FUEL CONDITION		
10. FUEL - MAIN (GAL) FUEL - AUX (GAL)		
11. SUB TOTAL RAMP CONDITION		
12. *LESS FUEL FOR START, TAXI, AND TAKE-OFF		
13. SUB TOTAL TAKE-OFF CONDITION		
14. LESS FUEL - MAIN (GAL)		
15. SUB TOTAL		
16. LESS FUEL - AUX (GAL)		
17. SUB TOTAL		
18. LESS FUEL - MAIN (GAL)		
19. LANDING CONDITION		

*Fuel for start, taxi and take-off is normally 21 lbs at an average mom/100 of 16.

USEFUL LOAD WEIGHTS AND MOMENTS
OCCUPANTS

WEIGHT	Front Seats		3rd and 4th Seats		5th and 6th Seats
	Fwd Position	Aft Position	Fwd Position	Aft Position	
	ARM 85	ARM 89	ARM 121	ARM 136	ARM 154
			MOM/100		
120	102	107	145	163	185
130	110	116	157	177	200
140	119	125	169	190	216
150	128	134	182	204	231
160	136	142	194	218	246
170	144	151	206	231	262
180	153	160	218	245	277
190	162	169	230	258	293
200	170	178	242	272	308

NOTE: OCCUPANT POSITIONS SHOWN ARE FOR THE SEATS ADJUSTED THE MAXIMUM RANGE. INTERMEDIATE POSITIONS WILL REQUIRE INTERPOLATION OF THE MOMENT/100 VALUES.

Section VI
Wt and Bal/Equip List

BEECHCRAFT Baron 55, A55
Serial TC-1 thru TC-501

BAGGAGE

Weight	NOSE	REAR	AFT
	COMPT	FS 131 TO 170	FS 170 TO 190
	ARM 31	ARM 150	ARM 180
	Mom/100	Mom/100	Mom/100
10	3	15	18
20	6	30	36
30	9	45	54
40	12	60	72
50	16	75	90
60	19	90	108
70	22	105	126
80	25	120	144
90	28	135	162
100	31	150	180
110	34	165	198
120	37	180	216
130	40	195	
140	43	210	
150	47	225	
160	50	240	
170	53	255	
180	56	270	
190	59	285	
200	62	300	
220	68	330	
240	74	360	
260	81	390	
270	84	405	
280		420	
300		450	
320		480	
340		510	
360		540	
380		570	
400		600	

BEECHCRAFT Baron 55, A55
Serial TC-1 thru TC-501

Section VI
Wt and Bal/Equip List

CARGO
FWD OF SPAR
(CENTER SEATS REMOVED)
ARM 108

Weight	<u>Moment</u> 100	Weight	<u>Moment</u> 100
10	11	110	119
20	22	120	130
30	32	130	140
40	43	140	151
50	54	150	162
60	65	160	173
70	76	170	184
80	86	180	194
90	97	190	205
100	108	200	216

CARGO
AFT OF SPAR
(CENTER & AFT SEATS REMOVED)
ARM 145

Weight	<u>Moment</u> 100	Weight	<u>Moment</u> 100
10	15	210	305
20	29	220	319
30	44	230	334
40	58	240	348
50	73	250	363
60	87	260	377
70	102	270	392
80	116	280	406
90	131	290	421
100	145	300	435
110	160	310	450
120	174	320	464
130	189	330	479
140	203	340	493
150	218	350	508
160	232	360	522
170	247	370	537
180	261	380	551
190	276	390	566
200	290	400	580

USABLE FUEL

		MAIN WING TANKS ARM 75	AUX WING TANKS ARM 93
Gallons	Weight	Mom/100	
5	30	23	28
10	60	45	56
15	90	68	84
20	120	90	112
25	150	113	140
30	180	135	167
35	210	158	195
40	240	180	223
44	264	198	
45	270	203	251
50	300	225	279
55	330	248	307
60	360	270	335
62	372		346
65	390	293	
70	420	315	
74	444	333	

*OIL

Quarts	Weight	<u>Moment</u> 100
24	45	19

*Included in Basic Empty Weight

**Section VI
Wt and Bal/Equip List**

**BEECHCRAFT Baron 55, A55
Serial TC-1 thru TC-501**

INTENTIONALLY LEFT BLANK

SECTION VII

SYSTEMS DESCRIPTION

TABLE OF CONTENTS

<i>SUBJECT</i>	<i>PAGE</i>
Airframe	7-5
Flight Controls	7-5
Control Surfaces	7-5
Control Column	7-5
Rudder Pedals	7-5
Trim Controls	7-6
Instrument Panel	7-6
Flight Instruments	7-6
Power Plant Instruments	7-6
Illustration	7-8, 7-9
Illustration	7-10, 7-11
Ground Control	7-7
Wing Flaps	7-7
Landing Gear System	7-7
Control Switch	7-12
Position Indicators	7-12
Safety Switch	7-12
Warning Horn	7-13
Manual Extension	7-13
Brakes	7-13
Baggage/Cargo Compartments	7-14
Aft Baggage/Cargo Compartment	7-14
Nose Baggage/Cargo Compartment	7-15
Seating	7-15

TABLE OF CONTENTS (Continued)

<i>SUBJECT</i>	<i>PAGE</i>
Doors, Windows, and Exits	7-16
Forward Cabin Door	7-16
Openable Cabin Windows	7-17
Control Locks	7-17
Power Plants	7-18
Power Plant Controls	7-18
Propeller, Throttle and Mixture	7-18
Induction Air	7-18
Lubrication System	7-18
Cowl Flaps	7-19
Propellers	7-19
Fuel System	7-22
Schematic	7-20, 7-21
Fuel Pressure Indicator	7-22
Fuel Crossfeed	7-24
Fuel Boost Pumps	7-24
Fuel Required for Flight	7-25
Electrical System	7-27
Schematic	7-26
Battery	7-27
Generators	7-27
Starters	7-28
External Power	7-28
Lighting Systems	7-29
Interior Lighting	7-29
Exterior Lighting	7-29
Heating and Ventilation System	7-30
Cabin Heating	7-30
Heater Operation	7-30
Heat Regulation	7-31
Heater Blower	7-31
Environmental Schematic	7-32, 7-33
Cabin Ventilation	7-34

TABLE OF CONTENTS (Continued)

<i>SUBJECT</i>	<i>PAGE</i>
Exhaust Vents	7-34
Individual Fresh Air Outlets	7-34
Oxygen System	7-35
Pitot and Static System	7-35
Pitot System	7-36
Normal Static System	7-36
Alternate (Emergency) Static System	7-36
Vacuum System	7-37
Stall Warning	7-37
Ice Protection Systems	7-38
Propeller and Windshield Anti-ice System (Fluid Flow)	7-38
Electrothermal Propeller Deice	7-38
Pitot Heat	7-39
Stall Warning Anti-ice	7-39
Engine Break-in Information	7-39

INTENTIONALLY LEFT BLANK

AIRFRAME

The BEECHCRAFT 55 and A55 BARON models are both four to five place all-metal, low-wing, twin-engine airplanes with retractable tricycle landing gear, and a conventional horizontal and vertical stabilizer.

FLIGHT CONTROLS

CONTROL SURFACES

Control surfaces are bearing supported and operated through push-pull rods and conventional cable systems terminating in bellcranks.

CONTROL COLUMN

The throw-over type control column for elevator and aileron control can be placed in front of either front seat. Pull the T-handle latch at the back of the control arm and position the control wheel as desired. Check for full freedom of movement after repositioning the control.

The optional dual control column is required for flight instruction.

RUDDER PEDALS

To adjust the rudder pedals, press the spring-loaded lever on the side of each pedal arm and move the pedal to its forward or aft position. The adjustment lever can also be used to place the right set of rudder pedals against the floor, (when the copilot brakes are not installed) when not in use.

TRIM CONTROLS

All trim tabs are adjustable from the control console. A position indicator is provided for each. The left aileron tab incorporates servo action in addition to its trimming purpose. Elevator trim is controlled by a hand wheel located to the left of the throttles. An elevator tab indicator dial is located above and to the left of the trim control hand wheel.

INSTRUMENT PANEL

FLIGHT INSTRUMENTS

The flight instruments are located on a floating panel directly in front of the pilot's seat. Standard flight instrumentation includes attitude and directional gyros, air-speed, altimeter, vertical speed, turn coordinator, and a clock. A magnetic compass is mounted above the instrument panel and an outside air temperature indicator is either installed in the windshield (TC-1 thru TC-190) or located on the left side panel (TC-191 thru TC-501). Located on the right side of the instrument panel is the standard vacuum gage for the instrument air system.

POWER PLANT INSTRUMENTS

Most of the engine instruments are located in the upper center of the instrument panel. The standard indicators for each engine are as follows: tachometers, manifold pressure, fuel pressure, fuel quantity, and loadmeters. Other indicators such as the exhaust gas temperature system, the propeller deice ammeter (or propeller alcohol quantity and deice pressure) are usually installed on the right side of the instrument panel. Two multi-purpose instruments, one for each engine, indicate cylinder head temperature, oil pressure, and oil temperature.

GROUND CONTROL

Spring-loaded linkage from the nose gear to the adjustable rudder pedals allows for nose wheel steering. Smooth turning is accomplished by allowing the airplane to roll while depressing the appropriate rudder pedal. The minimum wing tip turning radius, using partial braking action and differential power, is 29 feet 6 inches.

WING FLAPS

The wing flaps are controlled by a three-position switch, UP, OFF and DOWN, located on the left of the center console. The control must be pulled out of detent before it can be repositioned.

The flap position lights show green for the up position and red for the full-down landing position—intermediate 20-degree and 10-degree positions are indicated by lines painted on the leading edge of the left flap. The intermediate positions are reached when the marks are aligned with the trailing edge of the wing.

Limit switches automatically turn off the electric motor when the flaps reach the extremes of travel.

LANDING GEAR SYSTEM

CAUTION

Never taxi with a flat strut.

The landing gear is operated through adjustable linkage connected to an actuator assembly mounted beneath the front seats. The actuator assembly is driven by an electric motor. The landing gear may be electrically retracted and extended, and may be extended manually.

Section VII
Systems Description

BEECHCRAFT Baron 55, A55
Serial TC-1 thru TC-501

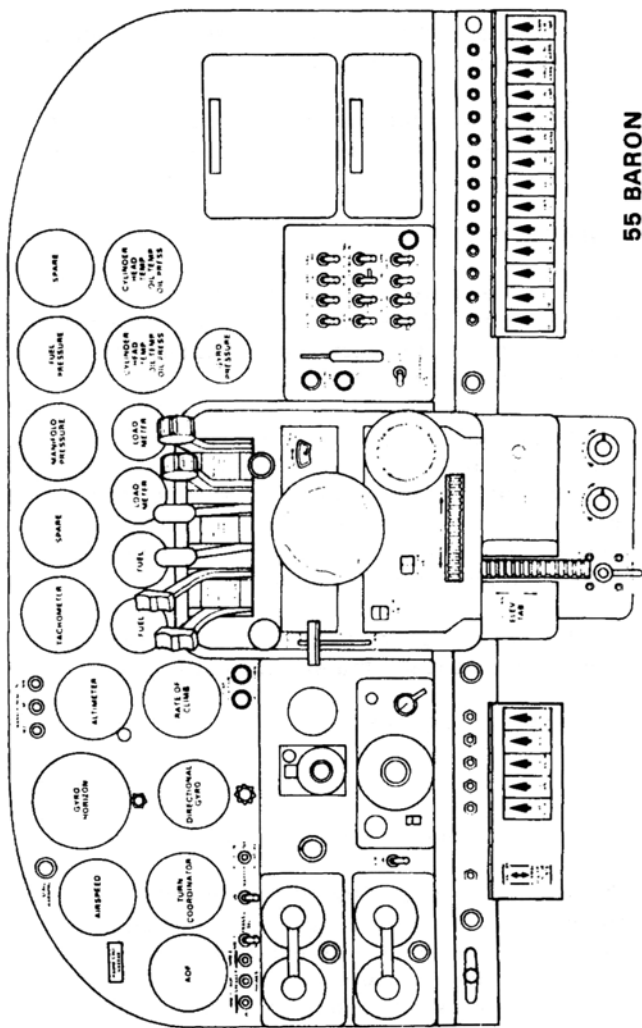

**BEECHCRAFT Baron 55, A55
Serial TC-1 thru TC-501**

**Section VII
Systems Description**

RIGHT SWITCH PANEL

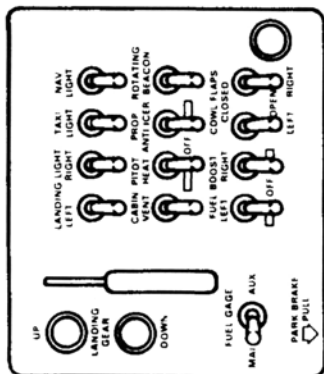

LEFT SIDE PANEL (TC-2 thru TC-23)

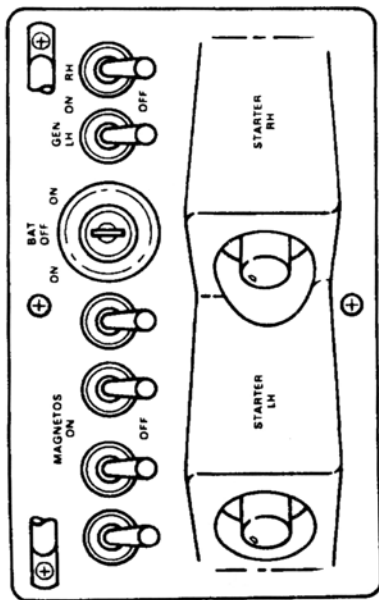

RIGHT SUBPANEL DOOR

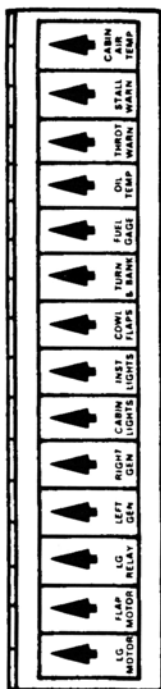

LEFT SUBPANEL DOOR

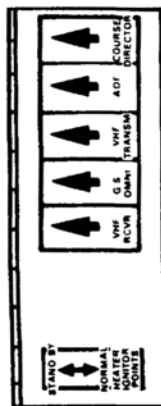

CONTROL SWITCH

The landing gear is controlled by a two-position switch on the right side of the control console. The switch handle must be pulled out of the safety detent before it can be moved to the opposite position. Never operate the landing gear electrically with the handcrank engaged.

CAUTION

Do not change the position of the control switch to reverse the direction of the landing gear while the gear is in transit, as this could cause damage to the retract mechanism.

POSITION INDICATORS

Landing gear position lights are located adjacent to the control switch. The lights, red for gear up and green for gear down, illuminate only when the gear has reached the fully retracted or extended position. In addition, a mechanical pointer at the base of the console shows the position of the nose gear during transit and in the full up or full down position.

SAFETY SWITCH

To prevent inadvertent retraction of the landing gear on the ground, a main strut safety switch opens the control circuit when the strut is compressed.

CAUTION

Never rely on the safety switch to keep the gear down during taxi or on take-off, landing roll, or in a static position. Always make certain that the landing gear switch is in the down position during these operations.

WARNING HORN

If either or both throttles are retarded below an engine setting sufficient to sustain two engine flight with the landing gear retracted, a warning horn will sound intermittently. During one engine operation, the horn can be silenced by advancing the throttle of the inoperative engine until the throttle warning horn switch opens the circuit.

MANUAL EXTENSION

The landing gear can be manually extended, but not retracted, by operating the handcrank on the rear of the pilot's seat. The landing gear handle must be in the down position and the landing gear MOTOR circuit breaker must be pulled before manually extending the gear. When the electrical system is operative, the landing gear may be checked for full down with the gear position lights, provided the landing gear RELAY circuit breaker is engaged. After the landing gear is down, disengage the handcrank. For electrical retraction of the landing gear after a practice manual extension use procedures outlined in the EMERGENCY PROCEDURES section.

If the landing gear was extended for emergency reasons, do not move any landing gear controls or reset any switches or circuit breakers until the airplane is on jacks, to prevent a gear retraction on the ground. These procedures are outlined in the EMERGENCY PROCEDURES section.

BRAKES

The brakes on the main landing gear wheels are operated by applying toe pressure to the top of the rudder pedals.

CAUTION

Continuous brake application of either the pilot's or copilot's brake pedals in conjunction with an overriding pumping action from the opposite brake pedals could result in the loss of braking action on the side which continuous pressure is being applied.

The parking brake control is located just to the right (TC-1 thru TC-190) or to the left (TC-191 and after) of the control console. To set the parking brakes, pull the control out and depress the pilot's toe pedals until firm. Push the control in to release the brakes.

NOTE

The parking brake should be left off and wheel chocks installed if the airplane is to be left unattended. Changes in ambient temperature can cause the brakes to release or to exert excessive pressures.

The brakes hydraulic fluid reservoir is accessible through the nose baggage door. Fluid level is checked with the dipstick attached to the reservoir cap. The brakes require no adjustments, since the pistons move outward to compensate for lining wear.

BAGGAGE/CARGO COMPARTMENTS

AFT BAGGAGE/CARGO COMPARTMENT

The aft baggage/cargo compartment is accessible through the baggage door on the right side of the fuselage. This area extends aft of the pilot's seats to the rear bulkhead. Because of structural limitations, this area is divided into three sections, each having a different weight limitation. Loading within the baggage/cargo compartment must be in accordance with the data in the WEIGHT AND BALANCE section. All cargo must be secured with the approved cargo retention systems.

WARNING

Do not carry hazardous material anywhere in the airplane.

Do not carry passengers in the baggage or cargo area unless secured in a seat.

NOSE BAGGAGE/CARGO COMPARTMENT

The forward baggage/cargo compartment is easily accessible through a large door on the right side of the nose. The door, hinged at the top, swings upward, clear of the loading area. Loading within this area must be within the limitations according to the **WEIGHT AND BALANCE** section. The nose baggage/cargo compartment incorporates the full width of the fuselage as usable space. This compartment also affords accessibility to some of the airplane's avionics. Straps are provided and should be used to secure any baggage or cargo loaded into the nose baggage/cargo compartment.

SEATING

To adjust any of the four standard seats forward or aft, pull up on the release bar below the seat and slide the seat to the desired position. The seat backs of all standard seats can be placed in any of four positions by operating a release lever on the inboard side of each seat. An option is available that provides for the seat backs on all standard seats (except the pilot's) to be placed in any position from vertical to fully reclined. Outboard armrests for all standard seats are built into the cabin sidewalls. A center armrest for the front seats can be elevated or positioned flush with the seat cushions. The center armrests for the standard rear seats are either removable (55) or can fold into a stowed position behind the seat backs (A55). The optional fifth seat can be folded up to provide additional floor space, or folded down to provide access to the extended baggage/cargo compartment.

DOORS, WINDOWS AND EXITS

FORWARD CABIN DOOR

The airplane has a conventional cabin door on the forward right side of the fuselage and when closed, the outside cabin door handle is spring loaded to fit into a recess in the door to create a flat aerodynamically clean surface. The door may be locked with a key. To open the door from the outside, lift the handle from its recess and pull until the door opens.

To close the cabin door from the inside, observe that the door handle is in the unlocked position. In this position, the latch handle is free to move approximately one inch in either direction before engagement of the locking mechanism. Then grasp the door and firmly pull the door closed. Rotate the door handle fully counterclockwise into the locked position. When the door is properly locked, the door latch handle is free to move approximately one inch in either direction.

NOTE

When checking the door latch handle, do not move it far enough to engage the door latch release mechanism.

Press firmly outward at the top rear corner of the door. If any movement of the door is detected, completely open the door and close again following the above instructions.

To open the door from the inside, depress the lock button and rotate the handle clockwise.

OPENABLE CABIN WINDOWS

To open window, release latch front of bar, pull bar at the bottom of the window out and upward. Window will open approximately two inches.

Close window by pulling inward and down on the bar at the bottom of the window. Resistance will be felt as the bar moves downward. Continue moving bar downward to its lowest position. Check that bar is locked by the latch.

NOTE

Windows are to be closed before take-off and during flight. While closing window, ascertain that the hinge pin (which allows the window to open fully for emergency exit) is securely in place.

CONTROL LOCKS

1. Insert the spring end of the rudder control locking pin into the hole at the top of the pilot's left rudder pedal.
2. Neutralize the pedals and insert the opposite end of the locking pin into the right pedal by compressing the spring.
3. Place the elevator and aileron controls in an approximately neutral position.
4. Insert the elevator-aileron control locking pin into the hole in the control column hanger and the hole in the underside of the control column tube.
5. Close the throttles and place the throttle lock over the throttle control knobs.

To lessen the possibility of taxi or takeoff with the control lock installed, remove the locking components in the following order: rudder, throttle and elevator-aileron.

POWER PLANTS

The BEECHCRAFT BARON 55 and A55 are each powered by two Continental IO-470-L six-cylinder, horizontally opposed, fuel injected engines rated at 260 hp at 2625 rpm.

POWER PLANT CONTROLS

PROPELLER, THROTTLE, AND MIXTURE

The control levers are grouped along the upper face of the control console. Their knobs are shaped so they can be identified by touch. A single controllable friction knob below and to the left of the control levers prevents creeping.

INDUCTION AIR

Induction air is available from filtered ram air or alternate air. Filtered ram air enters from above the engine inside the nacelle area. Should the filter become obstructed, a spring-loaded door on the side of the plenum will open automatically and the induction system will operate on alternate air taken from the nacelle area.

LUBRICATION SYSTEM

The engine oil system for each engine is the full pressure, wet sump type and has a 12-quart capacity. Oil operating temperatures are controlled by an automatic thermostat bypass control. The bypass control will limit oil flow through the oil cooler when operating temperatures are below normal and will permit the oil to bypass the cooler if it should become blocked.

The oil system may be checked through access doors in the engine cowling. A calibrated dip stick adjacent to the filler cap indicates the oil level. Due to the canted position of the engines, the dip sticks are calibrated for either right or left engines and are not interchangeable.

The oil grades listed in the Approved Engine Oils in the SERVICING section are general recommendations only, and will vary with individual circumstances. The determining factor for choosing the correct grade of oil is the average ambient temperature.

COWL FLAPS

The cowl flap for each engine is controlled by a separate switch located on the pilot's subpanel either to the right (55) or to the left (A55) of the control console. The cowl flap is closed when the switch is in the up position and open when the switch is down. An amber annunciator light adjacent to the cowl flap switches, illuminates when either switch is in the open position.

PROPELLERS

The engines are equipped with two blade, full feathering, constant speed propellers. Springs aided by counterweights move the blades to high pitch. Engine oil under governor-boosted pressure moves the blades to low pitch.

The propellers should be cycled occasionally during cold weather operation. This will help maintain warm oil in the propeller hubs so that the oil will not congeal.

Section VII
Systems Description

BEECHCRAFT Baron 55, A55
Serial TC-1 thru TC-501

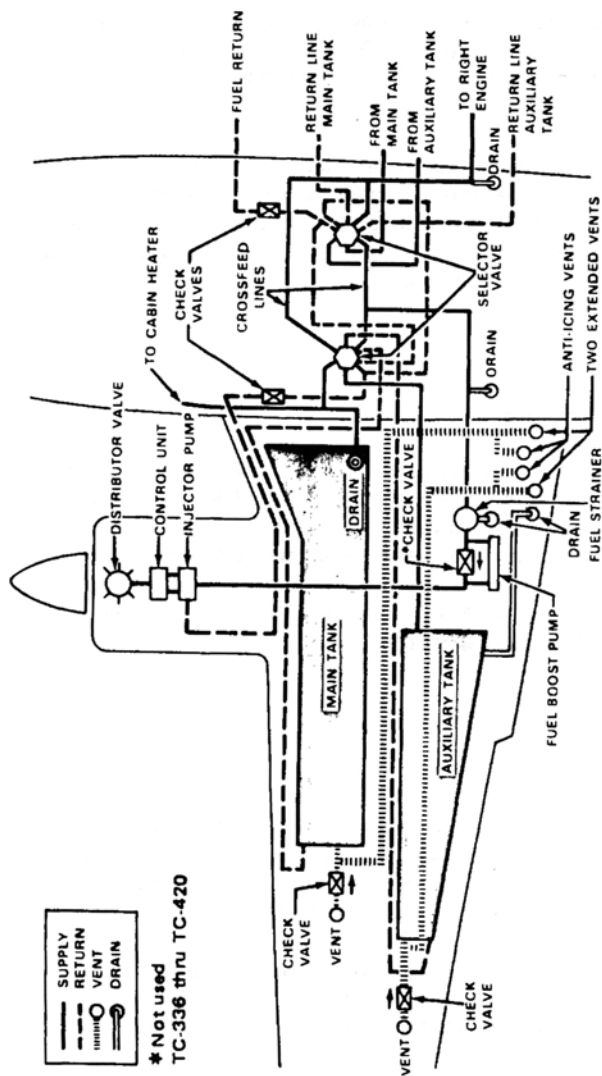

FUEL SCHEMATIC
TC-1 thru TC-250, TC-252 thru TC-370, TC-372 thru TC-420

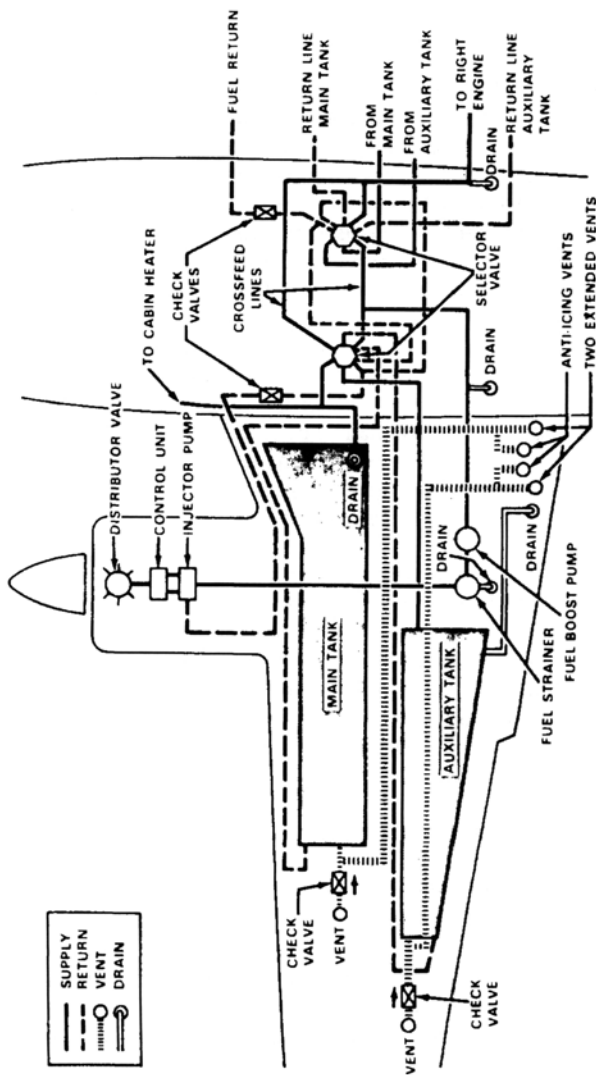

FUEL SCHEMATIC
TC-251, TC-421 thru TC-501

FUEL SYSTEM

The standard fuel tank installation consists of a 22-gallon main tank in each wing leading edge and a 31-gallon auxiliary tank in each wing panel outboard of the nacelle, for a total of 106 gallons of usable fuel with all tanks full. The optional fuel tank installation consists of a 37-gallon main tank in each wing leading edge and a 31-gallon auxiliary tank in each wing panel outboard of the nacelle, for a total of 136 gallons of usable fuel with all tanks full.

A vapor return line from each injector pump returns excess fuel to the tank from which it is being drawn, during either normal or emergency cross-feed operation. Each tank is filled at its own filler neck through an opening in the upper wing surface covered by a flush type filler cap. The fuel system is drained at eight locations, as shown in the accompanying fuel system schematic.

Fuel quantity is measured by float type transmitter units which convey signals to two indicators on the instrument panel. They indicate the amount of fuel in either the main tanks or the auxiliary tanks for their respective wings. A two-position selector switch to the right (55) or left (A55) of the control console, determines the tanks, main or auxiliary, to which the indicators are connected.

FUEL PRESSURE INDICATOR

The fuel pressure indicator registers metered fuel pressure at the fuel injection manifold valve. It does not indicate either engine-driven fuel pump pressure or fuel boost pump pressure. Red radials are placed at the minimum and maximum allowable operating fuel pressures. The green sectors indicate normal operating range. For fuel flow conversions see PERFORMANCE section.

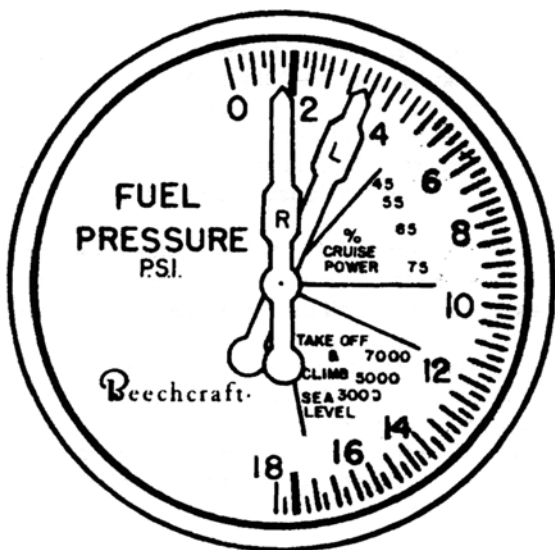

In the cruise power range the green sectors cover the fuel pressure required from 45% to 75% power. The lower edge of each sector is the normal-lean setting and the upper edge is the best power setting for that particular power range.

The takeoff and climb range is covered by green sectors for full power at various altitudes. The full power markings represent the maximum performance mixtures for the altitudes shown, permitting leaning of the mixture for maximum power and performance during high altitude takeoffs and full power climbs.

FUEL CROSSFEED

The separate, identical fuel supplies for each engine are interconnected by crossfeed lines. During normal operation each engine uses its own fuel pumps to draw fuel from its respective fuel tank arrangement. However, on emergency crossfeed operations the entire fuel supply of any or all tanks can be consumed by either engine.

On TC-181 and after, a mechanical interlock prevents both fuel selector valves being placed on crossfeed at the same time, as this would cut off the fuel supply for both engines.

The fuel crossfeed system is provided for use during emergency conditions in level flight only. The system is not to be used to transfer fuel from one tank to another or to balance fuel during flight. The procedure for using the crossfeed system is described in the EMERGENCY PROCEDURES section.

FUEL BOOST PUMPS

On TC-1 thru TC-420 except TC-251, an individual electric boost pump for each engine furnishes fuel pressure for starting and provides for near maximum engine performance should the engine-driven pump fail. Due to the in-line location of the boost pumps between the tanks and the selector valves, fuel may be drawn from any tank within the system by the boost pump for the operating engine.

On TC-251, TC-421 and after, an individual two-speed electric fuel boost pump is provided for each engine. HIGH pressure, OFF, or LOW pressure is selected with each fuel boost pump switch on the pilot's subpanel. High pressure is used for stabilizing the fuel pressure before start and provides near maximum engine performance should the engine-driven pump fail. In high ambient temperatures, low pressure should be used for ground operation, take-off, and climb. The location of the fuel boost pumps in the system permits fuel to be drawn from any tank within the system by the pump for the operating engine. The high pressure position should not be selected while the engine is operating except in the event of engine driven pump failure since the high pressure mode supplies a greater pressure than can be accepted by the injector system for a reduced power condition.

FUEL REQUIRED FOR FLIGHT

Flight planning and fuel loading are facilitated by the use of fuel quantity indicators that have been coordinated with the usable fuel supply. It is the pilot's responsibility to ascertain that the fuel quantity indicators are functioning and maintaining a reasonable degree of accuracy, and be certain of ample fuel for a flight. A minimum of 13 gallons of fuel is required in each main tank before takeoff. An inaccurate indicator could give an erroneous indication of fuel quantity. If the pilot is not sure that at least 13 gallons are in each main tank, add necessary fuel so that the amount of fuel will not be less than 13 gallons per main tank at takeoff. Plan for an ample margin of fuel for any flight.

**Section VII
Systems Description**

**BEECHCRAFT Baron 55, A55
Serial TC-1 thru TC-501**

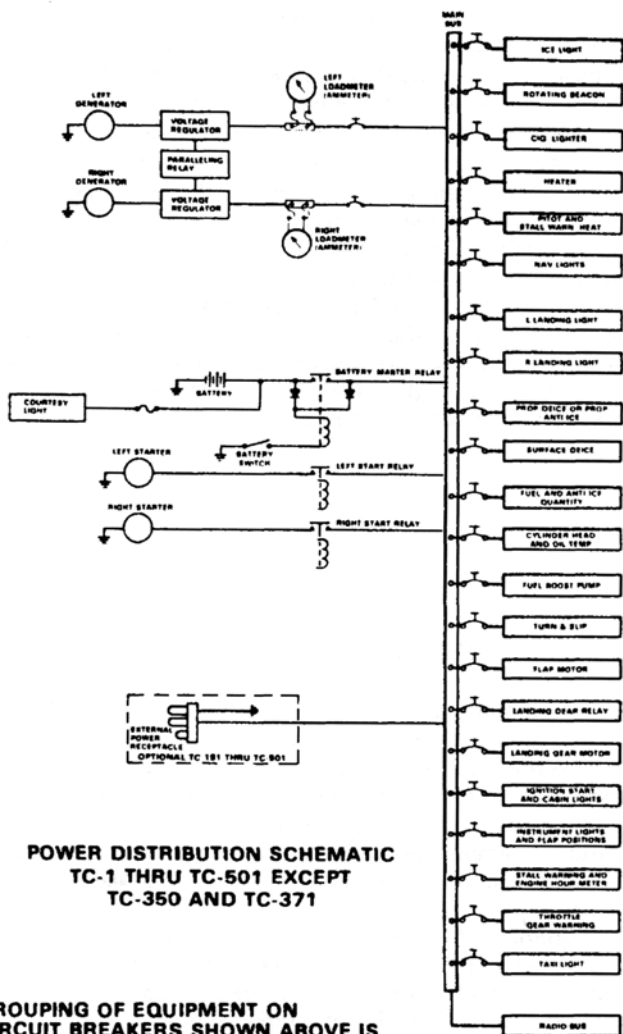

ELECTRICAL SYSTEM

In general, the airplane's circuitry is the single-wire, ground return type. The battery, magneto, starter, and generator switches are located on the left side panel. The Baron 55 has avionic system switches directly in front of the pilot, above the radio panel, and electrical system switches contained on a panel to the right of the control console. Individual circuit breakers are located along the bottom of each instrument panel. On the Baron A55 a panel to the left of the control console contains most of the electrical system switches and circuit breakers. Each is placarded as to its function. Avionics circuit breakers are located on the right subpanel.

BATTERY

One 17 ampere-hour, 24-volt lead acid battery is standard. Two 25 ampere-hour, 12-volt lead acid batteries, connected in series are offered as options. The battery installation is located beneath the floor of the nose baggage compartment. Battery servicing procedures are described in the SERVICING section. The battery can be turned off in flight and the generators will remain on the line.

GENERATORS

Two 25-ampere, 24-volt generators are standard equipment. The generators are belt-driven from the engine accessory section.

Two 40-ampere, 24-volt generators are offered as optional equipment.

The electrical output of each generator is automatically controlled by an individual voltage regulator and the system paralleling relay. Individual generator output is indicated by two loadmeters on the instrument panel. The power distribution system is protected by circuit breakers.

Section VII
Systems Description

BEECHCRAFT Baron 55, A55
Serial TC-1 thru TC-501

STARTERS (TC-2 thru TC-23)

The starters are relay-controlled and are actuated by push-button type, momentary-on switches located on the pilot's side panel. To energize the starter circuit, turn the magneto switches ON for the engine to be started and engage the appropriate starter switch. After starting, release the switch.

STARTERS (TC-1, TC-24 and after)

The starters are relay-controlled and are actuated by rotary type, momentary-on switches incorporated in the magneto/start switches located on the pilot's side panel. To energize the starter circuit, hold the magneto/start switch in the START position. After starting, release the switch to the BOTH position.

EXTERNAL POWER

The external power receptacle is located in the outboard side of the left nacelle and accepts a standard AN type plug. The power unit should be capable of delivering at least 300 amperes for starting. Before connecting an external power unit, turn the electrical systems and avionics off to avoid damage due to electrical surges. If the unit does not have a standard AN type plug, check the polarity (negative ground) and connect the positive lead from the external power unit to the center post of the airplane's receptacle. The negative lead connects to the other large post. When external power is connected, the battery switch should be turned on.

LIGHTING SYSTEM

INTERIOR LIGHTING

TC-1 thru TC-190

The cabin dome light is operated by an OFF-ON switch adjacent to the light. Two rheostat switches are located beneath the control console. One switch adjusts the intensity of the overhead instrument flood lights. The other switch regulates the lighting for the electrical panel, avionics panel, and the fuel selector panel, plus the trim tab and mechanical landing gear position indicators.

TC-191 thru TC-501

The cabin dome light is operated by an OFF-ON switch adjacent to the light. Three rheostat switches are located beneath the control console. One switch adjusts the intensity of the overhead instrument flood lights for all instruments except those directly above the electrical panel. Post lights for these instruments are controlled by the second switch. The third switch regulates the lighting for the electrical panel, avionics panel, and the fuel selector panel, plus the trim tab and mechanical landing gear position indicators.

EXTERIOR LIGHTING

The switches for the navigation lights, landing lights, rotating beacons, nose taxi light, and wing ice light(s) are grouped to the right of the control console (55) or along the top of the pilot's subpanel (A55). The landing lights in the leading edge of each wing tip are operated by separate switches. For longer battery and lamp service life, use the landing lights only when necessary. Avoid prolonged operation, during ground maneuvering, which could cause overheating. At night, reflections from rotating anti-collision lights on clouds, dense haze, or dust can produce optical illusions and vertigo. The use of these lights may not be advisable under instrument or limited VFR conditions.

HEATING AND VENTILATION SYSTEM

CABIN HEATING

A combustion heater in the nose supplies heated air to the cabin. Outlets are located forward of the pilot and copilot seats, at the rear of the copilot's seat, and at the rear of the right passenger seat. The fifth outlet provides heated air for windshield defrosting.

In flight, fresh ram air enters an intake on each side of the nose cone, passes through the heater, and is distributed to the cabin outlets. For ground operation, a blower maintains airflow through the system.

If a malfunction resulting in dangerously high temperatures should occur, a thermostat will ground a fuse in the heater power circuit. This renders the heater system, except the blower, inoperative. **MAKE CERTAIN ANY MALFUNCTION CAUSING THE OVERHEAT FUSE TO BLOW IS CORRECTED BEFORE ATTEMPTING TO OPERATE THE HEATER AGAIN.**

HEATER OPERATION

1. A two-position switch, placarded **CABIN VENT (55) or HEAT & BLOWER (A55)**, is used to place the heating system in operation. Move the switch to the **ON** position.
2. The **CABIN AIR T-handle control**, which regulates the amount of intake air, is below the left side of the pilot's subpanel. Push the **CABIN AIR** control full forward.

3. Pull out the CABIN HEAT control to the right of the CABIN AIR control to increase the temperature of the heated air. Push the control in to decrease temperature.
4. For windshield defrosting, push in the DEFROST control.

HEAT REGULATION

For maximum heat, the CABIN AIR control can be pulled partially out to reduce the volume of incoming cold air and permit the heater to raise the temperature of the admitted air. However, if the CABIN AIR control is pulled out more than halfway, the heater will not operate.

HEATER BLOWER

(TC-1 thru TC-190)

When the two-position switch on the right subpanel is placed in the CABIN VENT position, the blower will operate if the landing gear is in the extended position and the CABIN AIR control is more than halfway in. The blower will automatically shut off if the landing gear is retracted or the CABIN AIR control is pulled out more than halfway.

(TC-191 thru TC-501 except TC-371)

When the two-position switch on the pilot's subpanel is placed in the HEAT & BLOWER position, the blower will operate if the landing gear is in the extended position and the CABIN AIR control is more than halfway in. The blower will automatically shut off if the landing gear is retracted or the CABIN AIR control is pulled out more than halfway.

**Section VII
Systems Description**

**BEECHCRAFT Baron 55, A55
Serial TC-1 thru TC-501**

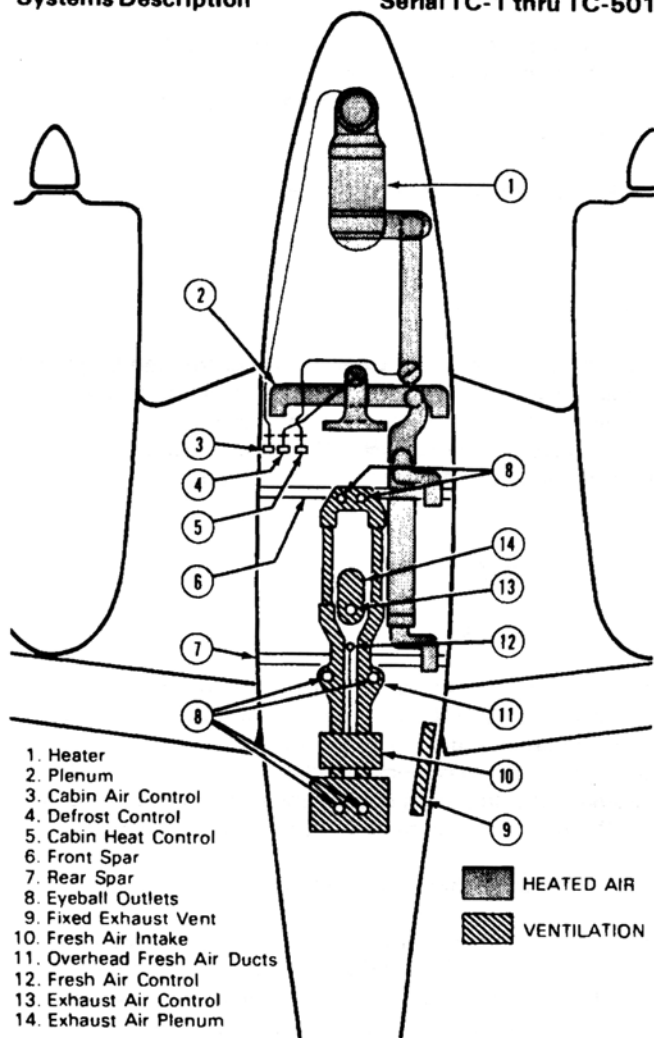

**HEAT AND VENTILATION SYSTEM SCHEMATIC
TC-1 thru TC-190**

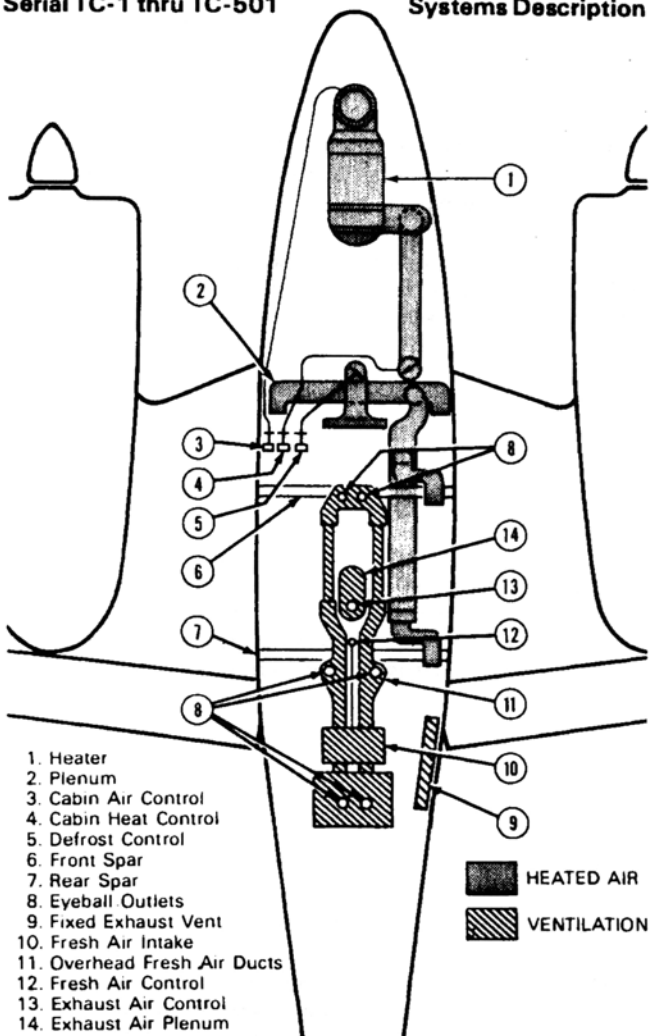

HEAT AND VENTILATION SYSTEM SCHEMATIC
TC-191 thru TC-501

Section VII
Systems Description

BEEHCRAFT Baron 55, A55
Serial TC-1 thru TC-501

CABIN VENTILATION

In flight, to provide unheated air for the same cabin outlets used for heating, push the CABIN AIR and CABIN HEAT controls forward.

For ventilation during ground operation, push the CABIN AIR control forward and place the two position CABIN VENT (55), HEAT & BLOWER (A55) switch on the sub-panel in the ON position.

EXHAUST VENTS

The adjustable cabin air exhaust vent is located aft of the radio speaker in the overhead panel. The overhead vent can be closed by a control located in the overhead panel. In addition, a fixed exhaust vent is located below the baggage door.

INDIVIDUAL FRESH AIR OUTLETS

Individual Overhead Fresh Air Outlets

A manually retractable air scoop on top of the cabin conducts outside air to individual fresh-air outlets in the overhead upholstery panel above each seat. The outlets can be manually adjusted to control both the quantity and direction of air flow. The air scoop may be closed by operating a push-pull control located on the overhead panel.

OXYGEN SYSTEM

WARNING

Proper safety measures must be employed when using oxygen, or a serious fire hazard will be created. **NO SMOKING PERMITTED.**

DESCRIPTION

The recommended masks are provided with the system. The masks are designed to be adjustable to fit the average person.

The oxygen system is available with either four, five or six outlets and with a 38 or 48 cu ft oxygen cylinder. The oxygen cylinder is located aft of fuselage station 170.0. Supply of oxygen to the system is controlled by a shut-off valve. The pressure indicator shows the supply of oxygen available (1850 psi is nominal pressure for a full supply in the cylinder).

The oxygen system is altitude compensated, therefore, flow is automatically varied to supply a higher oxygen flow at higher altitudes than at lower altitudes. The use of oxygen is recommended to be in accordance with current FAR operating rules.

PITOT AND STATIC SYSTEM

The pitot and static system provides a source of impact and static air for the operation of flight instruments.

PITOT SYSTEM

A standard pitot tube for the pilot's flight instruments is located under the left wing and the optional pitot tube for the copilot's instruments is located under the right wing.

A pitot heat switch, located on the instrument panel, supplies heat to the left and right pitot masts.

The pitot system needs no drain because of the location of the components.

NORMAL STATIC SYSTEM

Static air is taken from a flush static port located on each side of the aft fuselage. The static air is routed to the rate-of-climb indicator, altimeter and airspeed indicator.

To drain the static air line, remove one end of the hose which forms the static air line drain on the left side panel near the aft bulkhead and permit the system to drain.

ALTERNATE (EMERGENCY) STATIC SYSTEM

The alternate static air source is designed to provide a source of static pressure to the instruments from inside the fuselage should the outside static air ports become blocked. An abnormal reading of the instruments supplied with static air could indicate a restriction in the outside static air ports. A lever on the lower sidewall adjacent to the pilot, selects the normal or alternate static air source. When it is desired or required to use this alternate source of static air, select the ON position. To recognize the need and procedures for the use of alternate static air, refer to EMERGENCY PROCEDURES. Airspeed Calibrations and Altimeter Corrections charts are in the PERFORMANCE section.

VACUUM SYSTEM

Suction for the vacuum-operated gyroscopic flight instruments is supplied by two engine-driven vacuum pumps, interconnected to form a single system. If either pump fails, check valves automatically close and the remaining pump continues to operate all gyro instruments. A suction gage on the instrument panel indicates the amount of suction in the vacuum system in inches of mercury.

STALL WARNING

A stall warning indicator flashes a red light on the instrument panel (55) or sounds a warning (55, A55) as the airplane approaches a stall condition. The stall warning indicator is triggered by a sensing vane on the leading edge of the left wing. Irregular and intermittent at first, the warning signal will become steady as the airplane approaches a complete stall.

NOTE

Stall warning horn is inoperative when the Battery and Generator Switches are turned off. Airplane certification requires the stall warning system to be on during flight except in emergency conditions as stated in Section III.

In icing conditions, stalling airspeeds should be expected to increase due to the distortion of the wing airfoil when ice has accumulated on the airplane. For the same reason, stall warning devices tend to lose their accuracy. The sensing vane is installed on a plate that can be electrically heated, preventing ice from forming on the vane of the transducer. A switch on the instrument panel, placarded PITOT HEAT, supplies power to the heated pitot mast and

to the heating plate at the stall warning transducer. However, any accumulation of ice in the proximity of the stall warning vane reduces the probability of accuracy in the stall warning system whether or not the vane itself is clear of ice. For this reason, it is advisable to maintain an extra margin of airspeed above the stall speed.

ICE PROTECTION SYSTEMS

The wing ice light(s), used to check for ice accumulation during night operation, illuminates the wing leading edge. The light switch is on the pilot's subpanel.

PROPELLER ANTI-ICE SYSTEM (FLUID FLOW)

The system is designed to prevent the formation of ice. Always place the system in operation before encountering icing conditions.

Ice is prevented from forming on the propeller blades by wetting the blade anti-ice boots with anti-icing fluid. The anti-ice pump delivers a constant flow of fluid from the supply tank to the blade boots. The pump is controlled by an ON-OFF switch located to the right of the console (55) or on the pilot's subpanel (A55).

With a full reservoir, system endurance is approximately 120 minutes.

ELECTROTHERMAL PROPELLER DEICE (2 BLADES)

Propeller ice removal is accomplished by the electrically heated deice boots bonded to each propeller blade. The system uses the airplane electrical power to heat portions of the deice boots in a sequence controlled by a timer. The system is controlled by an ON-OFF switch on the pilot's

subpanel. When the system is turned on the ammeter will register 7 to 12 amperes. The system can be operated continuously in flight; it will function automatically until the switch is turned off. Propeller imbalance can be relieved by varying rpm. Increase rpm briefly, then return to the desired setting. Repeat if necessary.

CAUTION

Do not operate the system with the engines inoperative.

PITOT HEAT

Heating elements are installed in the pitot mast(s). Both heating elements are controlled by an individual switch located on the right side (55) or left side (A55) of the subpanel. The switch is placarded PITOT HEAT, and should remain off during ground operations, except for testing or for short intervals of time to remove ice or snow from the mast(s).

STALL WARNING ANTI-ICE (Optional)

The mounting pad and the stall warning vane are equipped with a heating element that is activated any time the switch placarded PITOT HEAT, is on.

ENGINE BREAK-IN INFORMATION

Use a straight mineral oil as recommended by the engine manufacturer throughout the break-in period. Drain the initial oil at 20 to 30 hours, replace with new mineral oil which is to be used until oil consumption stabilizes, usually a total of about 50 hours.

Section VII
Systems Description

BEECHCRAFT Baron 55, A55
Serial TC-1 thru TC-501

Drain and replace the engine oil as recommended in **HANDLING, SERVICING AND MAINTENANCE**. If operating conditions are unusually dusty or dirty, more frequent oil changes may be necessary. Oil changes are more critical during the break-in period than at any other time.

Use full throttle at recommended rpm for every take-off and maintain until at least 400 feet AGL, then reduce as necessary for cruise climb or cruise. Maintain the highest power recommended for cruise operations during the break-in period, avoiding altitudes above 8000 feet. Interrupt cruise power every 30 minutes or so by smoothly advancing to take-off power settings for about 30 seconds, then returning to cruise power settings.

Avoid long power-off descents especially during the break-in period. Maintain sufficient power during descent to permit cylinder head temperatures to remain in the green arc.

Minimize ground operation time, especially during warm weather. During the break-in period, avoid engine idling in excess of 15 minutes, especially in high ambient temperatures.

SECTION VIII

HANDLING, SERVICING AND MAINTENANCE

TABLE OF CONTENTS

<i>SUBJECT</i>	<i>PAGE</i>
Introduction	8-5
Publications	8-6
Airplane Inspection Periods	8-7
Preventative Maintenance That May Be Accomplished By A Certificated Pilot	8-7
Alterations or Repairs to Airplane	8-7
Ground Handling	8-8
Towing	8-8
Parking	8-9
Tie-Down	8-9
Main Wheel Jacking	8-10
Prolonged Out of Service Care	8-10
Storage	8-10
Flyable Storage - 7 to 30 Days	8-10
Mooring	8-10
Engine Preparation For Storage	8-11
During Flyable Storage	8-11
Fuel Cells	8-12
Flight Control Surfaces	8-12
Grounding	8-12
Pitot Tube(s)	8-12
Windshield and Windows	8-12
Preparation For Service	8-12

TABLE OF CONTENTS (Continued)

<i>SUBJECT</i>	<i>PAGE</i>
External Power	8-13
Checking Electrical Equipment	8-14
Servicing	8-15
Fuel System	8-15
Fuel Tanks	8-15
Fuel Drains	8-15
Fuel Strainers	8-16
Oil System	8-16
Battery	8-17
Tires	8-18
Shock Struts	8-18
Shimmy Damper	8-20
Brakes	8-21
Induction Air Filter	8-21
To Remove and Clean the Filter	8-22
Propellers	8-22
Propeller Anti-ice Tank (Fluid)	8-23
Oxygen System	8-23
Oxygen Cylinder Retesting	8-24
Minor Maintenance	8-24
Rubber Seals	8-24
Heating and Ventilating System	8-25
Magnetos	8-25
Cleaning	8-26
Exterior Painted Surfaces	8-26
Windshield and Windows	8-29
Surface Deice Boots	8-29
Engine	8-30
Interior	8-30
Lubrication Points	8-32 - 8-37
Recommended Servicing Schedule	8-38 - 8-43
Consumable Materials	8-44
Approved Engine Oils	8-48

TABLE OF CONTENTS (Continued)

<i>SUBJECT</i>	<i>PAGE</i>
Bulb Replacement Guide	8-50
Overhaul or Replacement Schedule	8-51
Special Conditions Cautionary Notice	8-51
Landing Gear	8-52
Power Plant	8-52
Fuel System	8-53
Instruments	8-54
Electrical System	8-54
Utility Systems	8-55
Flaps and Flight Controls	8-56
Miscellaneous	8-56

INTENTIONALLY LEFT BLANK

INTRODUCTION

The purpose of this section is to outline the requirements for maintaining the airplane in a condition equal to that of its original manufacture. This information sets the time frequency intervals at which the airplane should be taken to a BEECHCRAFT Aero or Aviation Center or International Distributor or Dealer for periodic servicing or preventive maintenance.

The Federal Aviation Regulations place the responsibility for the maintenance of this airplane on the owner and operator of the airplane who must ensure that all maintenance is done by qualified mechanics in conformity with all airworthiness requirements established for this airplane.

All limits, procedures, safety practices, time limits, servicing and maintenance requirements contained in this handbook are considered mandatory.

Authorized BEECHCRAFT Aero or Aviation Centers or International Distributors or Dealers will have recommended modification, service, and operating procedures issued by both FAA and Beech Aircraft Corporation, designed to get maximum utility and safety from the airplane.

If there is a question concerning the care of the airplane, it is important to include the airplane serial number in any correspondence. The serial number appears on the model designation placard attached to the underside of the fuselage just forward of the tiedown.

PUBLICATIONS

The following publications are available through BEECHCRAFT Aero or Aviation Centers and International Distributors or Dealers:

- | | |
|------------------|-----------------------------|
| 1. Shop Manual | 3. Service Instructions |
| 2. Parts Catalog | 4. Various Inspection Forms |

NOTICE

The following information may be provided to the holder of this manual automatically:

1. Original issues and revisions of Class I and II Service Instructions.
2. Original issues and revisions of FAA Approved Airplane Flight Manual Supplements.
3. Reissues and Revisions of FAA Approved Airplane Flight Manuals, Flight Handbooks, Owner's Manuals, Pilot's Operating Manuals and Pilot's Operating Handbooks.

This service is free and will be provided only to holders of this handbook who are listed on the FAA Aircraft Registration Branch List or the BEECHCRAFT International Owners Notification Service List, and then only if you are listed by airplane serial number for the model for which this handbook is applicable. For detailed information on how to obtain "Revision Service" applicable to this handbook or other BEECHCRAFT Service Publications consult a BEECHCRAFT Aero or Aviation Center or International Distributor or Dealer or refer to the latest revision of BEECHCRAFT Service Instructions No. 0250-010.

AIRPLANE INSPECTION PERIODS

1. FAA Required 100 Hour and/or Annual Inspections.
2. BEECHCRAFT Recommended Inspection Guide.
3. Continuous Care Inspection Guide.
4. See "Recommended Servicing Schedule" and Overhaul or Replacement Guide" for further inspection schedules.
5. Check the wing bolts for proper torque at the first 100 hour inspection and at the first 100 hour inspection after each reinstallation of the wing attach bolts.

PREVENTATIVE MAINTENANCE THAT MAY BE ACCOMPLISHED BY A CERTIFICATED PILOT

1. A certificated pilot may perform limited maintenance. Refer to FAR Part 43 for the items which may be accomplished.

To ensure proper procedures are followed, obtain a BEECHCRAFT Shop Manual for performing preventative maintenance.

2. All other maintenance must be performed by licensed personnel.

NOTE

Pilots operating airplanes of other than U. S. registry should refer to the regulations of the country of certification for information on preventative maintenance that may be performed by pilots.

ALTERATIONS OR REPAIRS TO AIRPLANE

The FAA should be contacted prior to any alterations on the airplane to ensure the airworthiness of the airplane is not violated.

NOTE

Alterations or repairs to the airplane must be accomplished by licensed personnel.

GROUND HANDLING

The three-view drawing in Section 1 shows the minimum hangar clearances for a standard airplane. Allowances must be made for any special radio antennas.

CAUTION

To insure adequate propeller clearance, always observe recommended shock strut servicing procedures and tire inflation pressures.

TOWING

One person can move the airplane on a smooth and level surface with the hand tow bar. Attach the tow bar to the tow pin on the nose gear lower torque knee. It is recommended to have someone in the airplane to operate the brakes.

CAUTION

Do not exert force on the propellers, control surfaces, or horizontal stabilizers. When towing with a tug, limit turns to prevent damage to the nose gear. Do not attempt to tow airplane backward by the tail tiedown ring. Do not tow when the main gear is obstructed by mud or snow. Also ensure the rudder lock is removed.

Care should be used when removing the tow bar to prevent damage to the lubrication fittings on the landing gear.

PARKING

The parking brake control is located either to the right of the control console (TC-1 thru TC-190) or just left of the elevator tab wheel (TC-191 and after) on the pilot's sub-panel. To set the parking brakes, pull control out and depress the pilot's toe pedals until firm. Push the control in to release the brakes.

NOTE

Excessive pedal pressure may prevent releasing of the parking brake.

The parking brake should be left off and wheel chocks installed if the airplane is to be left unattended. Changes in ambient temperature can cause the brakes to release or to exert excessive pressures.

TIE-DOWN

It is advisable to nose the airplane into the wind. Three tie-down lugs are provided: one on the lower side of each wing and a third at the rear of the fuselage.

1. Install the control locks.
2. Chock the main wheels, fore and aft.
3. Using nylon line or chain of sufficient strength, secure the airplane at the three points provided. **DO NOT OVER TIGHTEN**; if the line at the rear of the fuselage is excessively tight, the nose may rise and produce lift due to the angle of attack of the wings.
4. Release the parking brake.

If high winds are anticipated, a vertical tail post should be installed at the rear tie-down lug, and a tie-down line attached to the nose gear.

MAIN WHEEL JACKING

1. Check the shock strut for proper inflation to prevent damage to the landing gear door by the jack adapter and to facilitate installation of the adapter.
2. Insert the main wheel jack adapter into the main wheel axle.
3. A scissors-type jack is recommended for raising and lowering the wheel.
4. When lowering the wheel, exercise care to prevent compression of the shock strut, which would force the landing gear door against the jack adapter.

NOTE

Persons should not be in or on the airplane while it is on a main wheel jack.

PROLONGED OUT OF SERVICE CARE

STORAGE

Storage procedures are intended to protect the airplane from deterioration while it is not in use. The primary objectives of these measures are to prevent corrosion and damage from exposure to the elements.

Flyable Storage (7-30 days) has been considered here. For more extended storage periods, consult the Beech Airplane Shop Manual and Continental Service Bulletin M 74-9 or later issue.

FLYABLE STORAGE - 7 TO 30 DAYS

MOORING

If airplane cannot be placed in a hangar, tie down securely at the three points provided. Do not use hemp or manila

rope. It is recommended a tail support be used to compress the nose strut and reduce the angle of attack of the wings. Attach a line to the nose gear.

ENGINE PREPARATION FOR STORAGE

Engines in airplanes that are flown only occasionally tend to exhibit cylinder wall corrosion much more than engines that are flown frequently.

Run engines at least five minutes at 1200 to 1500 rpm with oil and cylinder head temperatures in the normal operating range.

Check for correct oil level and add oil if necessary to bring level to full mark.

DURING FLYABLE STORAGE

Each seven days during flyable storage, the propellers shall be rotated by hand. After rotating each engine six revolutions, stop the propellers 60° or 120° from the position they were in.

WARNING

Before rotation of propeller blades, ascertain magneto/start switches are OFF, throttles are in the CLOSED position, and mixture controls are in the IDLE CUT-OFF position. Always stand in the clear while turning propellers.

If at the end of 30 days, airplane will not be removed from storage, the engines shall be started and run. The preferred method will be to fly the airplane for 30 minutes, and up to, but not exceeding normal oil and cylinder temperatures.

FUEL CELLS

Fill to capacity to minimize fuel vapor and protect cell inner liners.

FLIGHT CONTROL SURFACES

Lock with internal and external locks.

GROUNDING

Static ground airplane securely and effectively.

PITOT TUBE(S)

Install cover(s).

WINDSHIELD AND WINDOWS

Close all windows and window vents. It is recommended that covers be installed over windshield and windows.

PREPARATION FOR SERVICE

Remove all covers and tape, clean the airplane and give it a thorough inspection, particularly landing gear, wheel wells, flaps, control surfaces, and pitot and static pressure openings.

Preflight the airplane.

EXTERNAL POWER

When using external power, it is very important that the following precautions be observed:

1. The airplane has a negative ground system. Exercise care to avoid reversed polarity. Be sure to connect the positive lead of the auxiliary power unit to the positive terminal of the airplane's external power receptacle and the negative lead to the negative terminal of the external power receptacle. A positive voltage must also be applied to the small guide pin.

NOTE

A negative ground external power source is required. If the polarity is reversed the avionics may be damaged.

2. To prevent arcing, make certain no power is being supplied when the connection is made.
3. Make certain that the battery switch is ON, all avionics and electrical switches OFF, and a battery is in the system before connecting an external power unit. This protects the voltage regulators and associated electrical equipment from voltage transients (power fluctuations).

CHECKING ELECTRICAL EQUIPMENT

Connect an auxiliary power unit as outlined in Starting Procedures. Ensure that the current is stabilized prior to making any electrical equipment or avionics check.

NOTE

If the external power unit has poor voltage regulation or produces voltage transients, the airplane electrical equipment connected to the unit may be damaged.

SERVICING

FUEL SYSTEM

FUEL TANKS

See Consumable Materials for recommended fuel grades.

All fuel tanks in each wing are serviced through two fuel fillers. Refer to the LIMITATIONS section for the usable fuel for both standard and optional fuel tank arrangements.

Ground the airplane with a static line before refueling and secure the filler caps immediately after filling. Before letting the airplane stand for several days, it is a good practice to fill the wing fuel system to ensure that the cell inner liners do not dry out and crack, allowing fuel to diffuse through the cell walls. Also, less moisture condensation will occur when fuel tanks are full. If the tanks are to be drained before storage, a coating of light engine oil should be sprayed or flushed onto the inner liners of the cells as a preservative.

FUEL DRAINS

Open each of the snap-type fuel drains to purge any water from the system. The standard fuel system has a total of eight drains. Two sump drains extend through the bottom of each wing. There is one drain in each wing wheel well for the fuel strainer, and two drains extending through the fuselage for the system low spot.

FUEL STRAINERS

To preclude the possibility of contaminated fuel, always cap any disconnected fuel lines or fittings. The fuel strainer in each wheel well should be inspected and cleaned with solvent at regular intervals. The frequency of inspection and cleaning will depend upon service conditions, fuel handling cleanliness, and local sand and dust conditions. At each 100-hour inspection the strainer plug should be removed from the fuel injection control valve and the fuel injection control valve screen washed in fresh cleaning solvent. After the strainer plug has been re-installed and safetied, the installation should be checked for leakage. A leading edge sump strainer, accessible through an access door on the bottom of the wing, should be cleaned periodically.

OIL SYSTEM

The engines are equipped with a wet sump, pressure type oil system. Each engine sump has a capacity of 12 quarts. The oil system may be checked through access doors in the engine cowling. A calibrated dipstick adjacent to the filler cap indicates the oil level. Due to the canted position of the engines, the dipsticks are calibrated for either right or left engines and are not interchangeable.

The oil should be changed every 25 hours under normal operating conditions. The oil drain is accessible through the cowl flap opening. The engines should be warmed to operating temperature to assure complete draining of the oil.

Moisture that may have condensed and settled in the oil sump should be drained occasionally by opening the oil drain plug and allowing a small amount of oil to escape. This is particularly important in winter, when the moisture will collect rapidly and may freeze.

The engine manufacturer recommends the use of ashless dispersant oils. In order to promote faster ring seating and oil control, a straight mineral oil should be used for the first change period or until oil consumption stabilizes. Dispersant oils must meet Teledyne Continental Motors Corporation Specification MHS-24B.

Aviation Grade Oil	Average Ambient Air Temperature
SAE 50	Above 5°C (40°F)
SAE 30	Below 5°C (40°F)

BATTERY

The battery is accessible by opening the forward baggage compartment door and removing the battery box cover from the floor of the compartment. Check the electrolyte level after each 25 hours of operation and add distilled water as necessary. Avoid filling over the baffles and never fill over the split ring or more than one-quarter inch over the separator tops.

Excessive water consumption may be an indication that the voltage regulators require resetting. The specific gravity of the electrolyte should be checked periodically and maintained within the limits placarded on the battery.

The battery box is vented overboard to dispose of electrolyte and hydrogen gas fumes discharged during the normal charging operation. To ensure disposal of these fumes the vent hose connections at the battery box should be checked frequently for obstructions.

TIRES

An inflation pressure of 50 psi should be maintained on the 6.50 x 8 main wheel tires and the 5.00 x 5 nose wheel tire. Maintaining recommended tire inflation will minimize tread wear and aid in preventing tire failure caused from running over sharp stones and ruts. When inflating tires, visually inspect them for cracks, breaks, or evidence of internal damage.

CAUTION

Beech Aircraft Corporation cannot recommend the use of recapped tires. Recapped tires have a tendency to swell as a result of the increased temperature generated during takeoff. Increased tire size can jeopardize proper function of the landing gear retract system, with the possibility of damage to the landing gear doors and retract mechanism.

SHOCK STRUTS

CAUTION

DO NOT taxi with a flat shock strut.

The shock struts are filled with compressed air and hydraulic fluid. The same procedure is used for servicing both the main and the nose gear shock struts. To service a strut, proceed as follows:

1. Jack the airplane, remove the air valve cap, depress the valve core, and allow the strut to fully deflate.

WARNING

Do not unscrew the valve body assembly until all air pressure has been released or it may be blown off with considerable force, causing injury to personnel or damage to equipment.

2. Carefully remove the valve body assembly.
3. Compress the strut and fill through the air valve assembly hole with hydraulic fluid (approximately one pint) until the fluid overflows.
4. Cycle the strut from full extension to compressed and refill. Repeat until no more fluid can be added to the strut in the compressed position.

NOTE

Cycling of the shock strut is necessary to expel any trapped air within the strut housing.

5. Install the air valve assembly.
6. With the airplane resting on the ground and the fuel cells full, inflate the nose gear strut until 4-1/2 inches of the piston are exposed and inflate the main gear struts until 3 inches of the piston are exposed. Rock the airplane gently to prevent possible binding of the piston in the barrel while inflating.

NOTE

It is recommended that the nose strut inflation dimension and the tire inflation pressures be carefully adhered to. Properly inflated tires and struts reduce the possibility of ground damage occurring to the propellers. Exercise caution when taxiing over rough surfaces.

7. Remove all foreign material from the exposed piston with a soft cloth moistened with hydraulic fluid.

CAUTION

If a compressed air bottle containing air under extremely high pressure is used, exercise care to avoid over-inflating the shock strut.

WARNING

NEVER FILL SHOCK STRUTS WITH OXYGEN.

SHIMMY DAMPER

The shimmy damper has a reservoir of fluid carried in the piston rod. Two coil springs installed in the piston rod keep fluid in the shimmy damper under pressure. As fluid is lost through leakage it is automatically replenished from the reservoir until the reservoir supply is exhausted.

To check the fluid level in the shimmy damper, insert a wire, approximately 1/32 inch in diameter, through the hole in the disc at the aft end of the piston rod until it touches the bottom of the hole in the floating piston. Mark the wire, remove it, and measure the depth of the insertion. When the shimmy damper is full, insertion depth is 2-3/16 inches, when empty, 3-1/16 inches.

NOTE

The measuring wire should be inserted in the hole in the floating piston rather than against the piston face to give a more accurate reading. To determine if the wire is inserted in the hole in the floating piston, insert the wire several times, noting insertion depth each time. When the wire is inserted in the hole, the depth will be about 1/4 inch greater than when it rests against the piston face.

When the shimmy damper is found empty or nearly empty, it should be refilled. See Shop Manual.

BRAKES

The brake hydraulic fluid reservoir is accessible through the nose baggage compartment. A dipstick is attached to the reservoir cap. Refer to Consumable Materials for hydraulic fluid specification.

The brakes require no adjustments since the pistons move to compensate for lining wear. See Shop Manual for specific brake wear limits information.

INDUCTION AIR FILTERS

The filters should be inspected for foreign matter at least once during each 50-hour operating period. In adverse climatic conditions, or if the airplane is stored, preflight inspection is recommended.

TO REMOVE AND CLEAN THE FILTER:

1. Remove the access plate in the top of the engine cowling (TC-221 and after) or the cowling upper section (prior to TC-221) secured by three screws at each front and rear corner and nine screws at the aft edge.
2. Remove the second access plate on top of the air box and slide out the filter.
3. Remove the filter and clean as noted by the manufacturer's instructions.
4. Reinstall the filter and the plates.

PROPELLERS

The daily preflight inspection should include a careful examination of the propeller blades for nicks and scratches.

Propeller operation, servicing, and maintenance instructions are contained in the propeller owner's manual furnished with the airplane.

WARNING

When servicing a propeller, always make certain that the ignition switch is off and that the engine has cooled completely. **WHEN MOVING A PROPELLER, STAND IN THE CLEAR; THERE IS ALWAYS SOME DANGER OF A CYLINDER FIRING WHEN A PROPELLER IS MOVED.**

PROPELLER ANTI-ICE TANK (FLUID)

The tank is located beneath the floor on the left side of the forward baggage compartment. The filler cap is accessible through an access door in the floor of the compartment. Capacity is 3 U.S. gallons of anti-ice fluid (see Consumable Materials). The tank should be drained and flushed twice a year.

OXYGEN SYSTEM

WARNING

Keep hands, tools, clothing, and oxygen equipment clean and free from grease and oil. **KEEP FIRE AWAY FROM OXYGEN.**

1. Read the pressure indicator. (The shutoff valve on the oxygen cylinder must be open.) On serials prior to TC-358 the pressure gage is located on the aft cabin bulkhead. On serials TC-358 and after a pressure gage and a separate oxygen control valve are grouped together on an oxygen console to the left of the pilot. If the oxygen cylinder is equipped with a gage, system pressure may be checked at the cylinder.

CAUTION

Always open the cylinder shutoff valve slowly to prevent damage to the system.

2. Close the cylinder shutoff valve, remove the cap from the filler valve, and attach the recharging outlet. Open valve on supply bottle.

3. Open the cylinder shutoff valve and fill the cylinder to 1800 \pm 50 psi (add 3.5 psi per degree above 70°F; subtract 3.5 psi per degree below 70°F).
4. Close the cylinder shutoff valve, close valve on the supply bottle, remove the recharging outlet, and replace the filler valve cap.
5. Reopen the cylinder shutoff valve to prepare system for use.

OXYGEN CYLINDER RETESTING

Oxygen cylinders used in the airplane are of two types. Light weight cylinders, stamped "3HT" on the plate on the side, must be hydrostatically tested every three years and the test date stamped on the cylinder. This bottle has a service life of 4,380 pressurizations or twenty-four years, whichever occurs first, and then must be discarded. Regular weight cylinders, stamped "3A", or "3AA", must be hydrostatically tested every five years and stamped with the retest date. Service life on these cylinders is not limited.

MINOR MAINTENANCE

RUBBER SEALS

To prevent sticking of the rubber seals around the windows, doors, and engine cowling, the seals should be coated with Oakite 6 compound. The compound is noninjurious to paint and can be removed by employing normal cleaning methods.

HEATING AND VENTILATING SYSTEM

The heater fuel pump filter in the nose wheel well should be removed and cleaned after each 100 hours of airplane operation. Remove the filter by turning the base of the pump counterclockwise. Wash the filter in clean unleaded gasoline and dry with compressed air.

The iris valve at the heater blower inlet should be lubricated occasionally with molybdenum disulfide (see Consumable Materials). The valve should never be lubricated with oil or any liquid lubricant which would collect dust.

Do not replace the overheat fuse until a thorough inspection of the system has determined the cause and the malfunction has been corrected.

MAGNETOS

Ordinarily, the magnetos will require only occasional adjustment, lubrication, and breaker point replacement. This work should be done by an authorized BEEHCRAFT Aero or Aviation Center or International Distributor or Dealer.

WARNING

To be safe, treat the magnetos as hot whenever a switch lead is disconnected at any point; they do not have an internal automatic grounding device. Otherwise, all spark plug leads should be disconnected or the cable outlet plate on the rear of the magneto should be removed.

CLEANING

EXTERIOR PAINTED SURFACES

WARNING

Do not expose the elevator trim tab hinge lines and their pushrod systems to the direct stream or spray of high-pressure soap-and-water washing equipment. Fluid dispensed at high pressure could remove the protective lubricant, allowing moisture from heavy or prolonged rain to collect at hinge lines and to freeze at low temperatures. After high-pressure or hand washing and at each periodic inspection, lubricate trim tab hinge lines and trim tab pushrod end fittings with BRAYCO 300, CRC 3-36, LPS No. 1, or WD-40. (See Consumable Materials.)

CAUTION

When cleaning wheel well areas with solvent, especially if high-pressure equipment is used, exercise care to avoid washing away grease from landing gear components. After washing the wheel well areas with solvent, lubricate all lubrication points, or premature wear may result.

Do not apply wax or polish to uncured painted surfaces. Waxes and polishes seal the paint from the air and prevent curing. Alkyd enamel (sometimes called "automotive enamel"), acrylic enamel, lacquer, and dope finishes require a curing period of approximately 90 days; acrylic urethane, polyester urethane, and epoxy finishes cure in seven days at 75°F.

Wash uncured painted surfaces with cold or lukewarm water and a **MILD NON-DETERGENT SOAP**. Any rubbing of the surface should be done gently and held to a minimum to avoid cracking the paint film.

Prior to cleaning, cover the wheels, making certain the brake discs are covered. Attach the pitot cover securely, and plug or mask off all other openings. Be particularly careful to mask off all static air buttons before washing or waxing. Use special care to avoid removing lubricant from lubricated areas. When using high-pressure washing equipment, keep the stream or spray clear of wheel bearings, propeller hub bearings, etc., and openings such as pitot masts, static air buttons, and avionics equipment overboard cooling ducts, which should be securely plugged or masked off. Avoid directing high-pressure sprays toward the fuselage, wings, and empennage from the rear, where moisture and chemicals might more easily enter the structure, causing corrosion damage to structural members and moving parts.

Hand washing may be accomplished by flushing away loose dirt with clean water, then washing with a mild soap and water, using soft cleaning cloths or a chamois. Avoid harsh, abrasive, or alkaline soaps or detergents which could cause corrosion or scratches. To remove oily residue or exhaust soot use a cloth dampened with aliphatic naphtha (see Consumable Materials), then wax or polish the affected area.

There is some variation in the procedures required for proper care of the several types of exterior paint. Alkyd enamel, lacquer, and dope finishes must be polished and waxed periodically to maintain luster and to assure protection from the weather. Acrylic enamel should be waxed, and may be polished, if desired. Acrylic urethane may be

Section VIII
Handling, Serv - Maint

BEEHCRAFT Baron 55, A55
Serial TC-1 thru TC-501

waxed for protection from the elements, but should not be polished unless polishing or buffing is required to restore a damaged area. Waxing of polyester urethane finishes, although not required, is permitted; however, use of "cleaner" waxes or polishes should be avoided, as these products cause eventual deterioration of the characteristic urethane gloss. Epoxy finishes should be waxed on a regular basis, and may be polished and buffed to restore appearance should "chalking" occur.

A buildup of wax on all of the above exterior paint finishes will yellow with age; therefore, wax should be removed periodically. Generally, aliphatic naphtha is adequate and safe for this purpose.

WINDSHIELD AND WINDOWS

The windshield and plastic windows should be kept clean and waxed at all times. To prevent scratches wash the windows carefully with plenty of soap and water, using the palm of the hand to feel and dislodge dirt and mud. A soft cloth, chamois or sponge may be used, but only to carry water to the surface. Rinse thoroughly, then dry with a clean, moist chamois. Rubbing the surface of the plastic with a dry cloth builds up an electrostatic charge which attracts dust particles in the air.

Remove oil and grease with a cloth moistened with isopropyl alcohol. Never use gasoline, benzine, alcohol, acetone, carbon tetrachloride, fire extinguisher fluid, anti-ice fluid, lacquer thinner or glass cleaner. These materials will soften plastic and may cause it to craze.

After thoroughly cleaning, the surface should be waxed with a good grade of commercial wax. The wax will fill in the minor scratches and help prevent further scratching. Apply a thin, even coat of wax and bring it to a high polish by rubbing lightly with a clean, dry, soft flannel cloth. Do not use a power buffer; the heat generated by the buffing pad may soften the plastic.

SURFACE DEICE BOOTS

The surfaces of the deice boots should be checked for indication of engine oil after servicing and at the end of each flight. Any oil spots that are found should be removed with a non-detergent soap and water solution. Care should be exercised during cleaning. Avoid scrubbing the surface of the boots as this will tend to remove the special graphite surfacing. The deice boots are made of soft, flexible stock which may be damaged if gasoline hoses are dragged over the surface of the boots or if ladders and platforms are rested against them.

ENGINE

Clean the engine with neutral solvent. Spray or brush the fluid over the engine, then wash off with water and allow to dry.

CAUTION

Do not use solutions which may attack rubber or plastic. Protect engine switches, controls, and seals; fluid applied at high pressure can unseat seals, resulting in contamination of the sealed systems.

INTERIOR

To remove dust and loose dirt from the upholstery, headliner, and carpet, clean the interior regularly with a vacuum cleaner.

Blot up any spilled liquid promptly with cleansing tissue or rags. Do not pat the spot; press the blotting material firmly and hold it for several seconds. Continue blotting until no more liquid is taken up. Scrape off sticky materials with a dull knife; then spot-clean the area.

Oily spots may be cleaned with household spot removers, used sparingly. Before using any solvent, read the instructions on the container and test it on an obscure place on the fabric to be cleaned. Never saturate the fabric with a volatile solvent; it may damage the padding and backing materials.

Soiled upholstery and carpet may be cleaned with foam-type detergent used according to the manufacturer's instructions. To minimize wetting the fabric, keep the foam as dry as possible and remove it with a vacuum cleaner.

The plastic trim, instrument panel, and control knobs need only be wiped with a damp cloth. Oil and grease on the control wheel and control knobs can be removed with a cloth moistened with isopropyl alcohol. Volatile solvents, such as mentioned in the article on care of plastic windows should never be used since they soften and craze the plastic.

Section VIII
Handling, Serv - Maint

BEECHCRAFT Baron 55, A55
Serial TC-1 thru TC-501

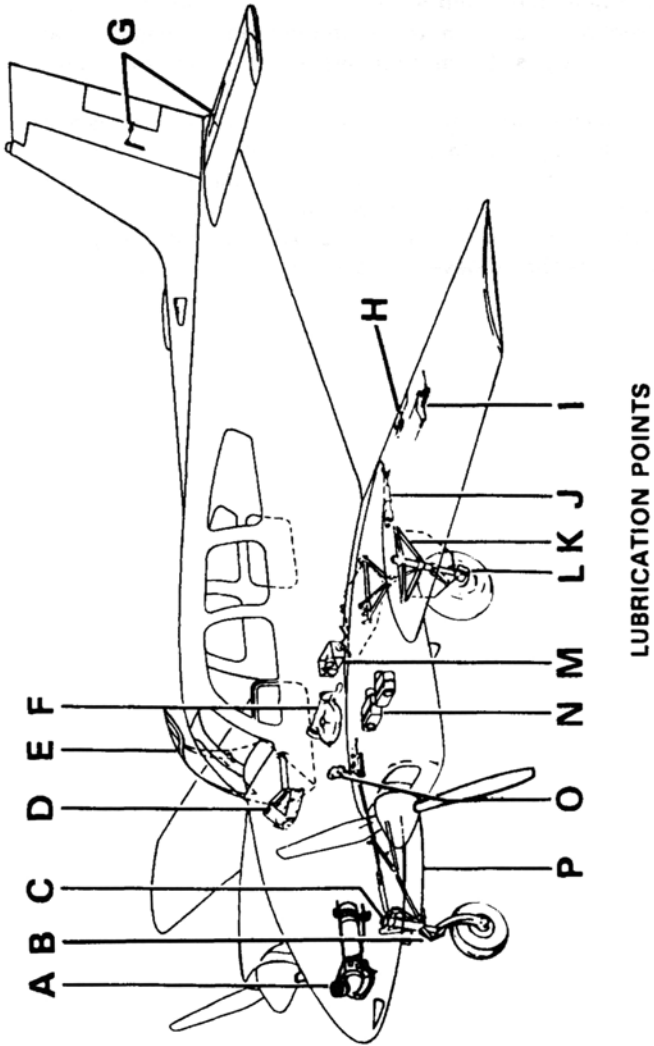

LUBRICATION POINTS

A

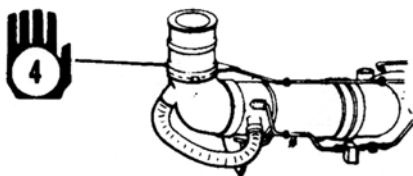

HEATER IRIS VALVE

B

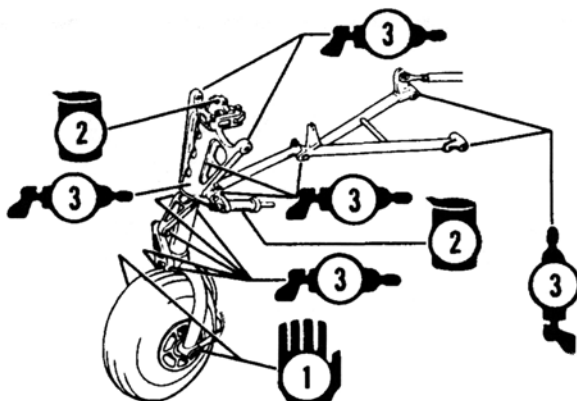

NOSE GEAR RETRACT

C

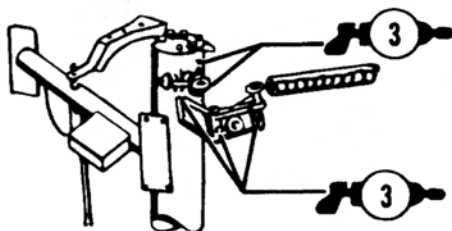

NOSE WHEEL STEERING

D

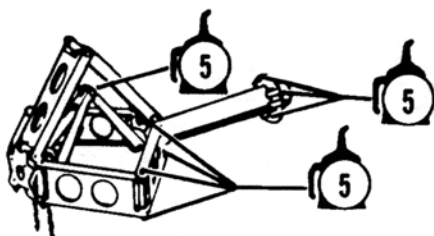

CONTROL COLUMN LINKAGE

E

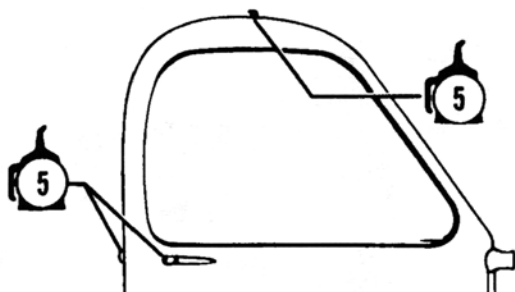

CABIN DOOR

F

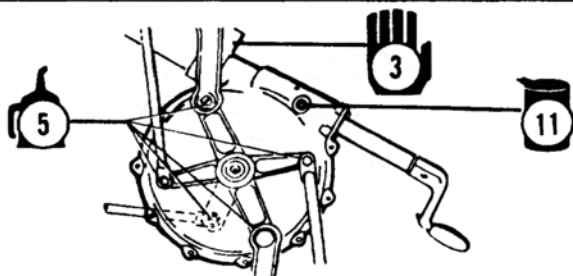

LANDING GEAR ACTUATOR GEAR BOX

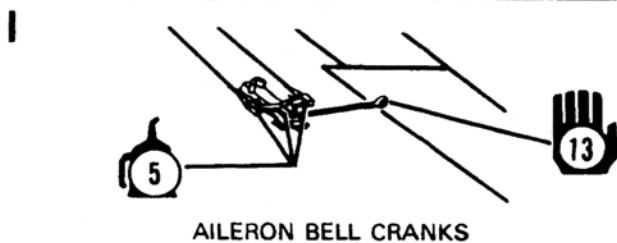
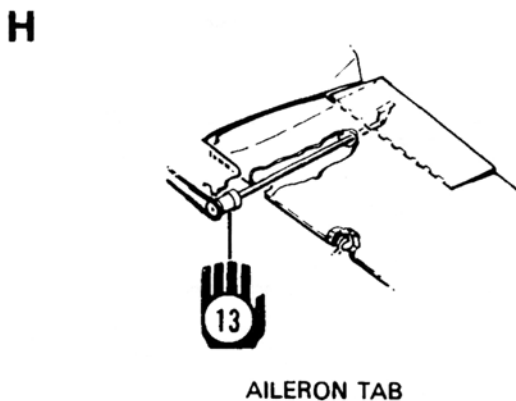
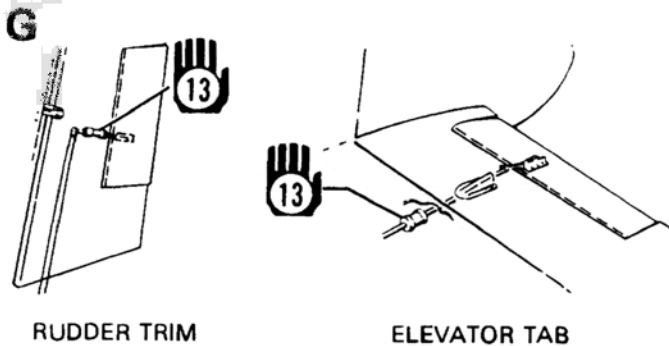

J

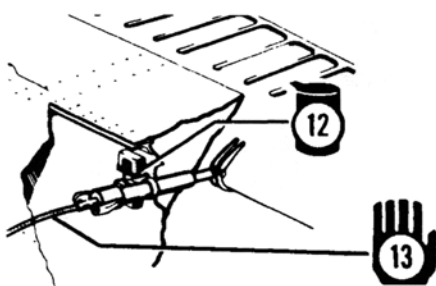

FLAP ACTUATOR

K

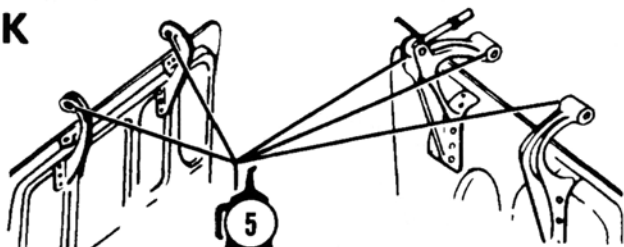

LANDING GEAR DOOR HINGES

L

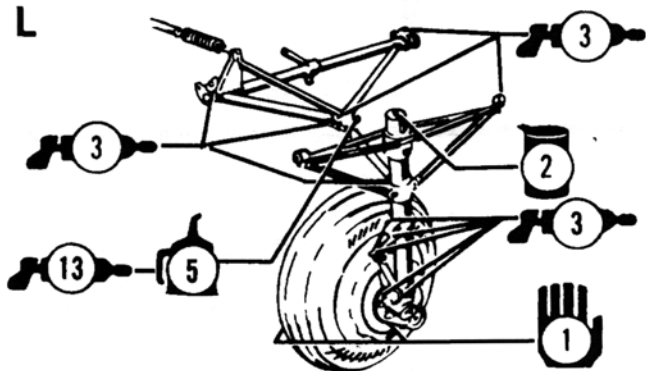

LANDING GEAR RETRACT

BEECHCRAFT Baron 55, A55
Serial TC-1 thru TC-501

Section VIII
Handling, Serv - Maint

M

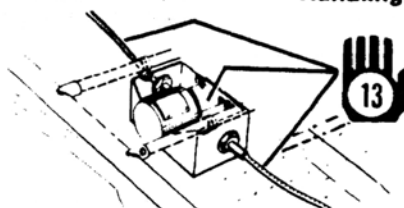

FLAP MOTOR GEAR BOX

O



RUDDER PEDALS

P

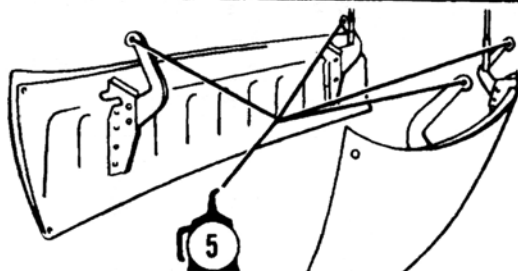

LANDING GEAR DOOR HINGES



HAND OR PACK

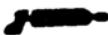

ZERK FITTING



FLUID CONTAINER



SQUIRT CAN

NOTE: Letters are keyed to the Service Schedule; Numbers refer to items in the Consumable Materials Chart.

RECOMMENDED SERVICING SCHEDULE

INTERVAL	ITEM	LOCATION (Letters refer to Lubrication Points Diagram)	(Number refers to item on Consumable Materials)
Pre-flight	Check engine oil level Drain main fuel cell drains Drain fuel strainer drains Drain fuel system low spot drains Drain heater fuel filter Drain box section cell Service fuel cells	Access door on upper cowling Lower wing surface (leading edge) Wing surface fwd of main wheel well Lower fuselage, inboard of wing root Nose wheel well Aft bottom wing surface Top of wings	6 - - - - - 7
25 Hrs.	Check battery electrolyte Change engine oil Clean oil screen	Fwd baggage compartment under floor Access plate on lower nacelle Access door on right side of cowl	See Shop Manual 6 9

50 Hrs.	Clean induction air filter †Lubricate landing gear uplock rollers	Access plate, induction scoop Main landing gear (L)	5
100 Hrs.	Clean fuel strainers Clean fuel injection control valve screen Clean heater fuel filter Clean heater fuel pump strainer †Lubricate landing gear uplock rollers Clean and check spark plugs Check magneto timing Lubricate landing gear door hinges Lubricate nose wheel steering mechanism Lubricate landing gear retract mechanism Lubricate wheel bearings	In wheel wells Access door on side of nacelle Nose wheel well Nose wheel well Main landing gear (L) Under cowl, both sides engine Engine compartment (N) Landing gear wheel wells (K) (P) Nose wheel well (C) Nose wheel and main gear wheel wells (B) (L) Landing gear (B) (L)	*9 *9 *9 *9 13 - - 5 3 3 1

*Clean with solvent and blow dry with compressed air.

RECOMMENDED SERVICING SCHEDULE

INTERVAL	ITEM	LOCATION (Letters refer to Lubrication Points Diagram)	(Number refers to item on Consumable Materials)
100 Hrs. (Cont.)	Lubricate cabin door mechanism Lubricate aileron bell cranks and control rod ends Lubricate control column linkage Lubricate rudder pedals Drain static air lines Replace gyro filters Clean oil separator	Cabin door latch (E) Access panel underside wings (I) Forward of instrument panel (D) Cockpit (O) Left aft cabin sidewall Back of gyro instruments On firewall	5 5, 13 5 5 - - -

300 Hrs.	Rod end bearings Service landing gear actuator gear box	Control system and landing gear Under front seats (F)	Oil or grease as required 11
600 Hrs.	Service landing gear motor-reduction gears Lubricate flap motor reduction gears	Under front spar cover (F) Under front spar cover (M)	3 13
900 Hrs.	Lubricate flap flex drives Lubricate flap actuators	Under front spar cover (M) Forward of flap underside of wing (J)	13 12
900 Hrs. or 5 years whichever occurs first	Lubricate rudder and elevator trim tab actuators Lubricate aileron trim tab actuators	Empennage (G) Aileron (H)	3 3

RECOMMENDED SERVICING SCHEDULE

INTERVAL	ITEM	LOCATION (Letters refer to Lubrication Points Diagram)	(Number refers to item on Consumable Materials)
As Req.	Service wing fuel system Service propeller anti-ice reservoir Service oxygen cylinder Service brake fluid reservoir Drain moisture from engine oil sump Drain static lines Service main gear struts Service nose gear strut Service shimmy damper Check brake lining wear Lubricate heater iris	At wing fillers Under left floorboard, forward baggage compartment Behind aft bulkhead Nose baggage compartment Through cowl flap opening Left aft cabin sidewall Top of each strut (L) Top of strut (B) Nose landing gear (B) Main landing gear wheels Forward nose compartment (A)	7 8 18 2 - - 2 2 2 - 4

Note 3	Replace emergency locator transmitter battery	At emergency locator	-
--------	---	----------------------	---

NOTES: 1. Anytime the control surfaces are altered, repaired, or repainted, they must be re-balanced per the Shop Manual.

2. Check the wing bolts for proper torque at the first 100-hour inspection and at the first 100-hour inspection after each reinstallation of the wing attach bolts.

3. Rechargeable Batteries: Recharge after one cumulative hour of use or after 50% of the useful charge life.

Non-rechargeable Batteries: Replace after one cumulative hour or as noted on the battery.

† TC-1 through TC-501 which have not been modified per S.I. 0448-211; the uplock roller should be lubricated with oil at 50 hours and hand packed with grease at 100 hours.

CONSUMABLE MATERIALS

Only the basic number of each Military Specification is included in the Consumable Materials Chart. No attempt has been made to update the basic number with the letter suffix that designates the current issues of the various specifications.

Vendors listed as meeting Federal and Military Specifications are provided as reference only and are not specifically recommended by Beech Aircraft Corporation; consequently, any product conforming to the specification listed may be used. The products listed below have been tested and approved for aviation usage by Beech Aircraft Corporation, by the vendor, or by compliance with the applicable specifications. Other products that are locally procurable which conform to the requirements of the applicable Military Specification may be used even though not specifically included herein.

It is the responsibility of the operator/user to determine the current revision of the applicable Military Specification prior to usage of that item. This determination may be made by contacting the vendor of a specific item.

CONSUMABLE MATERIALS

ITEM	MATERIAL	SPECIFICATION
1.	Lubricating Grease High Temperature	Aeroshell No. 5 or MIL-G-81322

CAUTION

Do not mix Aeroshell No. 5 with MIL-G-81322.
Thoroughly clean grease from bearings and bearing area before changing grease.

**BEECHCRAFT Baron 55, A55
Serial TC-1 thru TC-501**

**Section VIII
Handling, Serv - Maint**

ITEM	MATERIAL	SPECIFICATION
2.	Hydraulic Fluid	MIL-H-5606
*3.	Lubricating Grease, General Purpose, Wide Temperature	MIL-G-81322
4.	Molybdenum Disulfide	MIL-M-7866
5.	Lubricating Oil	SAE No. 20 or SAE 10W-30
**6.	Engine Oil	SAE 30 (Below 40°F) SAE 50 (Above 40°F) Approved Multi- viscosity Oils
***7.	Engine Fuel	Grade 100LL (Blue) preferred, 100 (Green)
8.	Anti-Ice Fluid	MIL-F-5566
9.	Solvent	Federal Specification, PD680
10.	Lubricant	Scintilla 10-86527
11.	Lubricant	Mobil Compound GG or Mobil 636
12.	Lubricating Oil, Gear	MIL-L-10324, or MIL-L-2105C, Grade 75W
13.	Grease, Aircraft and Instrument	MIL-G-23827

**Section VIII
Handling, Serv - Maint**

**BEECHCRAFT Baron 55, A55
Serial TC-1 thru TC-501**

ITEM	MATERIAL	SPECIFICATION
†14.	Lubricant, Rubber Seal	Oakite 6 Compound
15.	Naptha, Aliphatic	Federal Specification, TT-N-95
††16.	Tape, Antiseize Tetrafluorethylene	MIL-T-27730
17.	Leak Test Compound, Oxygen Systems	MIL-L-25567
18.	Oxygen, Aviator's Breathing	MIL-O-27210
19.	Lubricant	●BRAYCO 300 ●●CRC 3-36 ●●●LPS No. 1 ●●●●WD 40

- * In extremely cold climates use MIL-G-23827 grease in place of MIL-G-81322. (These greases harmful to paint.)
- ** Ashless dispersant oil (Continental Motors Corp. Spec. MHS-24B) recommended; straight mineral oils recommended during break-in period. See servicing data.
- *** If 100LL grade fuel (blue) is not available, use 100 (green) as minimum grade. See Engine Manufacturer's Service Letter for recommended maintenance and servicing techniques.

† Product of Oakite Products, Inc., 50 Valley Road, Berkley Heights, NJ 07922.

†† For sealing tapered pipe threads on high pressure oxygen lines.

- Product of Bray Oil Co.,
Los Angeles, Calif.
- Product of CRC Chemicals, Inc.,
Warminster, Pa. 18974
- Product of LPS Research Laboratories, Inc.,
2050 Cotner Ave,
W. Los Angeles, Calif. 90025
- Product of the WD-40 Company,
1061 Cudahy Place,
San Diego, Calif. 92110

**Section VIII
Handling, Serv - Maint**

**BEEHCRAFT Baron 55, A55
Serial TC-1 thru TC-501**

APPROVED ENGINE OILS

COMPANY	BRAND AND WEIGHT
BP Oil Corporation	BP Aero Oil
Castrol Limited (Australia)	Castrolaero AD Oil
Continental Oil Co.	Conoco Aero S
Delta Petroleum Co.	Delta Avoil Oil
Exxon Company, U.S.A.	Exxon Aviation Oil EE
Gulf Oil Corporation	Gulfpride Aviation AD
Mobil Oil Company	Mobil Aero Oil
Pennzoil Company	Pennzoil Aircraft Engine Oil
Phillips Petroleum Co.	Phillips 66 Aviation Oil Type A Phillips X/C Aviation Multiviscosity Oil SAE 20W-50 Phillips X/C Aviation Multiviscosity Oil SAE 25W-60
Quaker State Oil & Refining Corp.	Quaker State AD Aviation Engine Oil
Red Ram Limited (Canada)	Red Ram X/C Aviation Oil 20W-50
Shell Canada, Ltd.	Aeroshell Oil W

**BEEHCRAFT Baron 55, A55
Serial TC-1 thru TC-501**

**Section VIII
Handling, Serv - Maint**

COMPANY	BRAND AND WEIGHT
Shell Oil Company	Aeroshell Oil W SAE 15W/50 Aeroshell Oil W
Sinclair Refining Co.	Sinclair Avoil
Texaco, Inc.	Texaco Aircraft Engine Oil - Premium AD
Union Oil Co. of California	Union Aircraft Engine Oil

NOTE

This chart lists all oils which were certified as meeting the requirements of Teledyne Continental Motors Specification MHS-24B at the time this handbook was published. Any other oil which conforms to this specification may be used.

BULB REPLACEMENT GUIDE

LOCATION	NUMBER
Compass light	303
Cowl flap position light	313
Dome light, cabin	303
Electrical panel light	327
Flap position indicator light	327
Fuel selector placard light	327
Ice light	A-7796A-24
Instrument light, flood	303
Instrument light, post	327
Landing gear position light	327
Landing gear visual indicator light	356
Landing light	
Prior to TC-400	4523
TC-400 and after	4596
Map light	303
Navigation light, tail	1203
Navigation light, wing	1524
Overvoltage warning light (A55)	330
Reading light	1495
Rotating beacon	A-7079B-24 Grimes
Stall warning light (55)	327
Tab position indicator light	
55	356
A55	1819R
Taxi light	4570

OVERHAUL OR REPLACEMENT SCHEDULE

The first overhaul or replacement should be performed not later than the required period. The condition of the item at the end of the first period can be used as a criterion for determining subsequent periods applicable to the individual airplane or fleet operation, providing the operator has an approved monitoring system.

The time periods for inspection noted in this handbook are based on average usage and average environmental conditions.

SPECIAL CONDITIONS CAUTIONARY NOTICE

Airplanes operated for Air Taxi or other than normal operation and airplanes operated in humid tropics or cold and damp climates, etc., may need more frequent inspections for wear, corrosion and/or lack of lubrication. In these areas periodic inspections should be performed until the operator can set his own inspection periods based on experience.

NOTE

The required periods do not constitute a guarantee that the item will reach the period without malfunction, as the aforementioned factors cannot be controlled by the manufacturer.

Section VIII
Handling, Serv - Maint

BEECHCRAFT Baron 55, A55
Serial TC-1 thru TC-501

COMPONENT

OVERHAUL OR REPLACE

LANDING GEAR

Main gear assembly	Every 2000 hours
Nose gear assembly	Every 2000 hours
Actuator assembly	
All except -11	Every 2000 hours
P/N 95-810017-11	Every 4000 hours
Retract motor	Every 2000 hours
Retract motor brushes	Every 500 hours or on condition
Shimmy damper	Every 1000 hours
Wheels and tires	On condition
Brake assembly	On condition
Brake lining	On condition
Master cylinder	On condition
Shuttle valve assembly	On condition
Parking brake valve	On condition
All hose	On condition

POWER PLANT

NOTE

When an engine has been overhauled, or a new engine installed, it is recommended that low power settings not be used until oil consumption has stabilized. The average time for piston ring seating is approximately 50 hours.

Engine	*Every 1500 hours
Engine controls	On condition
Engine vibration isolator mounts	Engine change or on condition
Exhaust system	On condition
Engine driven fuel pump	1500

COMPONENT	OVERHAUL OR REPLACE
Oil cooler	On condition (replace when contaminated)
Propeller (Hartzell)	**1500 hours or 4 years.
Propeller (McCauley)	***1500 hours or 5 years.
Propeller controls	On condition
Propeller governor	At engine overhaul but not to exceed 1500 hours or 3 years
Vacuum pumps	Every 1200 hours
All hose	Hose carrying flammable liquids at engine overhaul or every 5 years. All other hose on condition.

FUEL SYSTEM

Fuel cells and strainer drain valves	On condition
Wing fuel quantity transmitters	On condition
Fuel cell drain valve	On condition
Fuel system check valves	On condition
Fuel selector valves	Inspect every 500 hours Overhaul every 1200 hours
Aux fuel pump	Every 1200 hours
All hose	Hose carrying flammable liquids at engine overhaul or every 5 years. All other hose on condition.
Vent line check valve	On condition

Section VIII
Handling, Serv - Maint

BEECHCRAFT Baron 55, A55
Serial TC-1 thru TC-501

COMPONENT

OVERHAUL OR REPLACE

INSTRUMENTS

Turn coordinator	On condition
Altimeter	Every 24 months per FAA Directive (Inspect and Calibrate)
Directional gyro	On condition
Gyro horizon	On condition
Gyro pressure	On condition
Engine indicator units	On condition
Airspeed indicator	On condition
Rate-of-climb	On condition
Fuel pressure gage	On condition
Manifold pressure indicator	On condition
Tachometer	On condition
Free air temperature indicator	On condition
Deice pressure gage	On condition
All hose	On condition
Suction gage	On condition

ELECTRICAL SYSTEM

Dynamic brake relay	On condition
Battery master relay	On condition
Paralleling relay	On condition
All other relays	On condition
Voltage regulator	On condition
Starter	At engine over- haul or replace on condition
Starter relay	On condition
Generator	On condition
Landing gear selector switch	1200 hours - replace

COMPONENT OVERHAUL OR REPLACE

UTILITY SYSTEMS

Cabin heater	Pressure test every 500 hours of heater operation or every 1000 hours of airplane operation and overhaul every 1500 hours of heater operation or 3000 hours of airplane operation (whichever comes first)
Heater ignition assembly	Switch points every 1000 hours of heater operation and replace every 2000 hours of heater operation (See Shop Manual)
Heater blower	On condition
Heater fuel pump	On condition
Heater fuel shut-off valve	On condition
Oxygen regulator	Every 2000 hours or 48 months
Oxygen cylinder (3HT)	Hydrostatically test every 3 years, replace every 24 years or 4,380 refills (ICC Regulation)
Oxygen cylinder (3A or 3AA)	Hydrostatically test every 5 years; no replacement duration
All hose	On condition
Propeller/windshield anti-ice pump	On condition
Vacuum regulator	On condition

Section VIII
Handling, Serv - Maint

BEECHCRAFT Baron 55, A55
Serial TC-1 thru TC-501

COMPONENT

OVERHAUL OR REPLACE

FLAPS AND FLIGHT CONTROLS

Flight controls	On condition
Aileron tab actuator	On condition
Elevator tab actuator	On condition
Rudder tab actuator	On condition
Flap track rollers	Every 1000 hours
Flap motor and drives	Every 2000 hours
Flap motor brushes	On condition
Flap actuators	Every 2000 hours
Flap flexible shaft	Every 2000 hours

NOTE

Any time the control surfaces are altered, repaired, or repainted, they must be rebalanced per Shop Manual.

MISCELLANEOUS

Seat belts or Shoulder Harnesses	Inspect every 12 months, replace on condition
Hand fire extinguisher	Inspect every 12 months, recharge as necessary

* The recommended engine overhaul period applies only to engines with nickel-coated exhaust valves or nimonic exhaust valves, provided that normal periodic inspections are properly carried out. Engines that should conform to a shorter TBO period are listed in Teledyne Continental Motors Corporation Service Bulletin M79-14, Rev. I, dated April 21, 1980, or later issue. Continental recommends a maximum of 1200 hours TBO on engines employed in aerial top dressing, dusting, or spraying.

With particular attention to throttle response, smooth power and oil consumption, a qualified mechanic must determine that the engine is operating normally at the time of each periodic inspection.

** Refer to Hartzell Propeller, Inc. Service Letter No. 61F, dated August 31, 1979, or later issue.

*** Applies only to propellers with hub serial number 71XXXX and higher; all other propellers; 1200 hours or 5 years.

Section VIII
Handling, Serv - Maint

BEECHCRAFT Baron 55, A55
Serial TC-1 thru TC-501

INTENTIONALLY LEFT BLANK

SECTION IX

SUPPLEMENTS

NOTE

The supplemental data contained in this section is for equipment that was delivered on the airplane including standard optional equipment that was available, whether it was installed or not. Supplements for equipment for which the vendor obtained a Supplemental Type Certificate were included as loose equipment with the airplane at the time of delivery. These and other supplements for other equipment that was installed after the airplane was delivered new from the factory should be placed in this Supplements Section of this Pilot's Operating Handbook and FAA Approved Airplane Flight Manual.

**Section IX
Supplements**

**BEEHCRAFT Baron 55, A55 -
Serial TC-1 thru TC-501**

NOTE

Supplements applicable to equipment other than that installed may, at the discretion of the owner/operator, be removed from the manual.

PILOT'S OPERATING HANDBOOK
and
FAA APPROVED AIRPLANE FLIGHT MANUAL
LOG OF SUPPLEMENTS

<i>FAA Supplements must be in the airplane for flight operation when subject equipment is installed:</i>				
Supp. No.	Part Number	Subject	Rev. No.	Date
1.	55-590000-51	Goodyear Electro-thermal Propeller Deice System		10/78
2.	95-590014-47	Goodrich Reservoir Type Pneumatic Deicing System		10/78
3.	131391	Manual Cowl Flaps (Kit 55-9017)		6/80

**Section IX
Supplements**

**BEEHCRAFT Baron 55, A55
Serial TC-1 thru TC-501**

INTENTIONALLY LEFT BLANK

BEECHCRAFT LANDPLANES

MODEL 95-55 SERIES

PILOT'S OPERATING HANDBOOK AND FAA APPROVED AIRPLANE FLIGHT MANUAL SUPPLEMENT

for the

GOODYEAR ELECTROTHERMAL PROPELLER DEICE

GENERAL

The information in this supplement is FAA approved material and must be attached to the Pilot's Operating Handbook and FAA Approved Airplane Flight Manual when the airplane is equipped with a Goodyear Electrothermal Propeller Deice System that has been installed in accordance with BEECHCRAFT FAA approved data.

This document supersedes or adds to the Pilot's Operating Handbook and FAA Approved Airplane Flight Manual only where covered in the items contained herein.

LIMITATIONS

Do not operate the system unless engine is operating.

Airplanes equipped with approved emergency static air source, surface deicing systems, pitot heat, heated stall warning, windshield defogging or storm windows, and external antenna mast capable of withstanding ice load are considered to be equipped for flight into icing conditions as governed by operational practices of Bureau of Flight Standards Release No. 434. When not equipped accordingly a placard as shown must be installed.

FAA Approved
Revised: October, 1978
P/N 55-590000-51

1 of 4

PLACARDS

On Instrument Panel:

WARNING
THIS AIRCRAFT IS NOT FULLY EQUIPPED
FOR FLIGHT IN ICING CONDITIONS

EMERGENCY PROCEDURES

1. Loss of one generator, off-load unnecessary electrical equipment. Turn off the propeller deice system while operating the cabin heater blower or the landing gear motor. Monitor electrical loads so as not to exceed generator capacity.

2. Abnormal Reading on Propeller Deice Ammeter

- a. Zero Amps

Check propeller deice switch. If the circuit breaker in the switch has tripped, a wait of approximately 30 seconds is necessary before resetting the switch to the ON position. If ammeter reads 0 and switch has not tripped or if ammeter still reads 0 after the switch has been reset, turn the switch off and consider the propeller deice system inoperative.

- b. Zero to 7 Amps

If propeller deice system ammeter occasionally or regularly indicates less than 7 amps, operation of the propeller deice system can continue unless serious propeller imbalance results from irregular ice throw-offs.

FAA Approved
Revised: October, 1978
P/N 55-590000-51

c. 11 to 15 Amps

If propeller deice system ammeter occasionally or regularly indicates 11 to 15 amps, operation of the propeller deice system can continue unless serious propeller imbalance results from irregular ice throw-offs.

d. More than 15 Amps

If the propeller deice system ammeter occasionally or regularly indicates more than 15 amps, the system should not be operated unless the need for propeller deice is urgent.

NORMAL PROCEDURES

WARNING

To minimize slip ring pitting, do not operate the system with engines inoperative.

PREFLIGHT

1. With engines operating, place propeller deice switch in the ON position.
2. Check propeller deice system ammeter for reading of 7 to 11 amperes.
3. A small momentary deflection of the needle may be noticed approximately every 30 seconds: This is due to the switching action of the timer and is an indication of normal operation of the system.

FAA Approved
Revised: October, 1978
P/N 55-590000-51

IN FLIGHT

1. To place the system in operation, move propeller deice switch to the ON position. The system may be operated continuously in flight and will function automatically until the switch is turned off.
2. Propeller imbalance may be relieved by varying rpm. Increase rpm briefly and return to desired setting, repeating if necessary.

PERFORMANCE - No change

Approved:

for *Donald H. Peter*
Chester A. Rembleske
Beech Aircraft Corporation
DOA CE-2

**BEECHCRAFT 95 and 95-55
SERIES LANDPLANES**

**PILOT'S OPERATING HANDBOOK AND
FAA APPROVED AIRPLANE FLIGHT MANUAL
SUPPLEMENT**

for the

**GOODRICH RESERVOIR TYPE
PNEUMATIC DE-ICING SYSTEM**

GENERAL

This document is to be attached to the Pilot's Operating Handbook and FAA Approved Airplane Flight Manual when the airplane is equipped with a Goodrich Reservoir Type Pneumatic De-icing System in accordance with BEECHCRAFT FAA approved data.

LIMITATIONS

1. Stall speeds are increased 4 kts/5 mph in all configurations with de-icers operating.
2. System capacity.

RESERVOIR PRESSURE (PSIG)	CYCLES AVAILABLE	ENDURANCE AT ONE CYCLE PER THREE MINUTES
100	4	12 min
500*	22	1 hr 6 min
1000	44	2 hrs 12 min
1500	66	3 hrs 18 min
2000	89	4 hrs 27 min
2500	112	5 hrs 3 min
3000**	134	6 hrs 42 min

*Recharge reservoir

**Maximum operating pressure

**FAA Approved
Revised: October, 1978
P/N 95-590014-47**

3. System endurance

The above table is presented so that the operator may estimate system endurance in time or cycles remaining. Use of the system is on a demand basis rather than a cycle basis. (1/4" to 1/2" of ice buildup rather than cycling at specific time intervals - demand cycling to be no more frequent than once every three minutes).

4. Instrument markings

De-icer pressure: Low pressure gage: Green arc,
15 to 25 psi.
High pressure gage: Red line,
3000 psi.

EMERGENCY PROCEDURES

For manual emergency deflation of the de-icers:
Cycling control valve - PUSH IN

NORMAL PROCEDURES

PREFLIGHT CHECK:

1. Observe reservoir pressure. Gage indicates only when air supply valve is open. Recharge reservoir if below 500 psi (reservoir pressure should be at least 500 psi).
2. Observe low pressure gage. Gage should indicate 15-25 psi. Reset and lock regulator if necessary.
3. Actuate cycling valve and observe De-icer inflation.
4. Observe deflation of De-icers. Deflation should be rapid and complete.

CAUTION

Vacuum source for De-icers is the right engine-driven vacuum pump. If the right engine is not operating, vacuum is not available. De-icers will deflate under this condition, but will not reach a vacuum "holddown" condition.

5. Normal inflation and deflation time is five to eight seconds.
6. Close remotely operated reservoir air supply valve.

OPERATION

1. When de-icing is required, pull "air supply" control to "arm" system; then pull de-icer "cycle control" for each cycle desired.
2. After 1/4" to 1/2" of ice buildup on leading edges, actuate cycling valve. When de-icers become fully inflated, the cycling valve will snap shut connecting the de-icer and the vacuum lines, deflating the system. Refer to OPERATING LIMITATIONS for system endurance; after each cycle is completed push control in to re-arm for next cycle. Sufficient pressure should be reserved to cycle the boots prior to landing.
3. When de-icing is no longer required, close remotely operated reservoir air supply valve.

PERFORMANCE - No change

Approved:

for 
for

Chester A. Rembleske
Beech Aircraft Corporation
DOA CE-2

FAA Approved
Revised: October, 1978
P/N 95-590014-47

3 of 3



**BEECHCRAFT BARON 95-55, 95-A55 and 95-B55
LANDPLANES (TC-1 thru TC-1607)
PILOT'S OPERATING HANDBOOK AND FAA
APPROVED AIRPLANE FLIGHT MANUAL
SUPPLEMENT
FOR
MANUAL COWL FLAPS
(BEECH KIT NO. 55-9017)**

GENERAL

The information in this supplement is FAA-Approved material and must be attached to the Pilot's Operating Handbook and FAA Approved Airplane Flight Manual when the airplane has been modified by installation of manual cowl flaps in accordance with Beech-approved data.

The information in this supplement supersedes or adds to the basic Pilot's Operating Handbook and FAA Approved Airplane Flight Manual only as set forth within this document. Users of this manual are advised always to refer to the supplement for possibly superseding information and placarding applicable to operation of the airplane.

LIMITATIONS - No change

EMERGENCY PROCEDURES - No change

NORMAL PROCEDURES

BEFORE STARTING

1. Seats - POSITION AND LOCK SEAT BACKS UPRIGHT

**FAA Approved
Issued: June, 1980
P/N 131391**

2. Seat Belts - FASTEN
Shoulder Harnesses if installed - FASTEN
3. Parking Brake - SET
4. All Avionics - OFF
5. Oxygen - CHECK QUANTITY AND OPERATION
6. Landing Gear Handle - DOWN
7. Cowl Flaps - CHECK, OPEN
8. Fuel Selector Valves - CHECK OPERATION THEN
SET TO MAIN
9. All Circuit Breakers, Switches and Equipment Controls
- CHECK
10. Battery Switch - ON

CAUTION

The generator/alternator control switches must be turned OFF prior to connecting an auxiliary power unit for starting, battery charging or electrical equipment check-out. This procedure protects the voltage regulators and system electrical equipment from voltage transients (power fluctuations).

11. Fuel Quantity Indicators - CHECK QUANTITY, MAIN
AND AUXILIARY. Fuel quantity selector switch to
MAIN. (See LIMITATIONS for take-off fuel)
12. Landing Gear Position Lights - CHECK

PERFORMANCE - No change

WEIGHT AND BALANCE - No change

FAA Approved
Issued: June, 1980
P/N 131391

SYSTEMS DESCRIPTION

COWL FLAPS

The push-pull cowl flap control for each engine is located on the lower center console. The cowl flap is closed when the control is pushed in and open when the control is pulled out.

HANDLING, SERVICING AND MAINTENANCE - No change

APPROVED

Donald St Peter

for

W. H. Schultz
Beech Aircraft Corporation
BOA CE-2

FAA Approved
Issued: June, 1980
P/N 131391

3 of 3



BEECHCRAFT

SECTION X

SAFETY INFORMATION

TABLE OF CONTENTS

INTRODUCTION	10-4
GENERAL.....	10-7
Do's	10-7
Dont's.....	10-9
GENERAL SOURCES OF INFORMATION ...	10-10
Rules and Regulations	10-10
Airworthiness Directives	10-11
Airman Information, Advisories and Notices -	
FAA Airman's Information Manual.....	10-11
Airman's Information Manual	10-11
Advisory Information.....	10-13
FAA Advisory Circulars	10-13
FAA General Aviation News	10-18
FAA Accident Prevention Program	10-19
GENERAL INFORMATION ON SPECIFIC	
TOPICS	10-20
Flight Planning.....	10-20
Passenger Information Cards	10-21
Inspections - Maintenance.....	10-22
Flight Operations	10-22
General	10-22
Turbulent Weather	10-22
Flight in Icing Conditions	10-25
Mountain Flying.....	10-33
March, 1981	10-1

TABLE OF CONTENTS (Cont'd)

Flight Operations (Cont'd).....	10-34
VFR - Low Ceilings	10-34
VFR at Night.....	10-35
Vertigo - Disorientation	10-35
Flight of Multi-Engine Airplanes with One Engine Inoperative	10-38
Minimum Control Speed Airborne (Vmca).....	10-41
Intentional One-Engine Inoperative Speed (Vsse)	10-42
Best Single Engine Rate-of-Climb Speed (Vyse).....	10-42
Best Single Engine Angle-of-Climb Airspeed (Vxse)	10-43
Single Engine Service Ceiling.....	10-44
Basic Single Engine Procedures.....	10-44
Engine Failure on Take-Off	10-45
When to fly, Vx, Vy, Vxse, and Vyse	10-46
Stalls, Slow Flight and Training	10-47
Spins	10-50
Descent.....	10-55
Vortices - Wake Turbulence	10-56
Takeoff and Landing Conditions.....	10-57
Medical Facts for Pilots	10-58
General	10-58
Fatigue.....	10-58
Hypoxia	10-59
Hyperventilation	10-61
Alcohol	10-62
Drugs.....	10-63
Scuba Diving	10-64
Carbon Monoxide and Night Vision.....	10-64

TABLE OF CONTENTS (Cont'd)

ADDITIONAL INFORMATION	10-64
Special Conditions	10-66
Maintenance	10-66

INTRODUCTION

The best engineering and manufacturing craftsmanship have gone into the design and building of all BEECHCRAFTS. Like any other high performance airplane, they operate efficiently and safely only in the hands of a skilled pilot.

You must be thoroughly familiar with the contents of your operating manuals, placards, and check lists to insure safe utilization of your airplane. When the airplane was manufactured, it was equipped with one or more of the following: placards, Owners Manual, FAA Flight Manual, Pilots Operating Handbook and FAA Approved Flight Manual. For simplicity and convenience we will refer to all official manuals in various models as the "Information Manual". If the airplane has changed ownership, the Information Manual may have been misplaced or may not be current. If missing or out of date, replacement Information Manuals must be obtained from any BEECHCRAFT Aviation Center as soon as possible.

For your added protection and safety, we have developed this special publication of safety information to refresh owners' and pilots' knowledge of a number of safety subjects. These subjects must

be reviewed periodically and kept with the airplane, along with the Information Manual and other documents required for operation of the airplane.

Topics in this publication are dealt with in more detail in FAA Documents and other articles pertaining to the subject of safe flying. The safe pilot is familiar with this literature.

BEECHCRAFT airplanes are designed and built to provide owners and pilots with many years of safe and efficient transportation. By maintaining it properly and flying it prudently, you will realize its full potential.

WARNING

Because your aircraft is a high performance, high speed transportation vehicle, designed for operation in a three-dimensional environment, special safety precautions must be observed to reduce the risk of fatal or serious injuries to the pilot(s) and occupant(s).

It is mandatory that you fully understand the contents of this manual and the other operating and maintenance manuals which accompany the aircraft;

Section X
Safety Information

BEECHCRAFT

that FAA requirements for ratings, certifications and review be scrupulously complied with; and that you allow only persons who are properly licensed and rated, and thoroughly familiar with the contents of the Information Manual, to operate the aircraft. IMPROPER OPERATION OR MAINTENANCE OF AN AIRCRAFT, NO MATTER HOW WELL BUILT INITIALLY, CAN RESULT IN CONSIDERABLE DAMAGE OR TOTAL DESTRUCTION OF THE AIRCRAFT ALONG WITH SERIOUS OR FATAL INJURIES TO ALL OCCUPANTS.

.BEECH AIRCRAFT CORPORATION

GENERAL

As a pilot, you are responsible to yourself and to those who fly with you, to other pilots and their passengers, and to people on the ground, to fly wisely and safely.

The following material in this Safety Section covers several subjects in limited detail. Here are some condensed Do's and Don'ts.

DO'S

Be thoroughly familiar with your airplane, know its limitations and your own.

Be current in your airplane, or fly with a qualified instructor until you are current/proficient.

Pre-plan all aspects of your flight - including weather and adequate fuel reserves.

Use services available - Weather briefing, in-flight weather and Flight Service Station.

Carefully pre-flight your airplane.

Use the approved check list.

Section X
Safety Information

BEECHCRAFT

Have more than enough fuel for takeoff, plus the trip, and an adequate reserve.

Be sure your weight loading and C.G. are within limits.

Pilot(s) and passengers must use seat belts and shoulder harnesses at all times.

Be sure all loose articles and baggage are secured.

Check freedom of all controls during pre-flight inspection and before takeoff.

Maintain the prescribed airspeeds in takeoff, climb, descent and landing.

Avoid big airplane wake turbulence.

Preplan fuel and fuel tank management before the actual flight. Utilize auxiliary tanks only in level cruise flight. Take off and land on the fullest main tank.

Practice emergency procedures at safe altitudes and airspeeds, preferably with a qualified instructor pilot, until the required action is instinctive.

Keep your airplane in good mechanical condition.

Stay informed and alert; fly in a sensible manner.

DON'TS

Don't take off with frost, ice or snow on the airplane.

Don't take off with less than minimum recommended fuel, plus adequate reserves, and don't run the tank dry before switching.

Don't fly in a reckless, show-off, careless manner.

Don't fly into thunderstorms or severe weather.

Don't fly in possible icing conditions unless the airplane is approved and properly equipped.

Don't fly close to mountainous terrain.

Don't apply controls abruptly or with high forces that could exceed design loads of the airplane.

Don't fly into weather conditions that are beyond your ratings or current proficiency.

Don't attempt any take off or landing without using the check list.

Section X
Safety Information

BEECHCRAFT

Don't fly when physically or mentally exhausted or below par.

Don't trust to luck.

GENERAL SOURCES OF INFORMATION

There is a wealth of information available to the pilot created for the sole purpose of making your flying safer, easier and faster. Take advantage of this knowledge and be prepared for an emergency in the remote event that one should occur.

You, as a pilot, have responsibilities under government regulations. These are designed for your protection and the protection of your passengers. Compliance is mandatory.

RULES AND REGULATIONS

F.A.R. Part 91, General Operating and Flight Rules, is a document of law governing operation of aircraft and the owner's and pilot's responsibilities. This document covers such subjects as:

Responsibilities and authority of the pilot-in-command

Certificates required
Liquor and drugs
Flight plans
Pre-flight action
Fuel requirements
Flight rules
Maintenance, preventative maintenance,
alterations, inspection, and maintenance records

These are only some of the topics covered. It is the owner's and pilot's responsibility to be thoroughly familiar with all items in F.A.R. Part 91 and to follow them.

AIRWORTHINESS DIRECTIVES

F.A.R. Part 39 specifies that no person may operate a product to which an airworthiness directive issued by the FAA applies, except in accordance with the requirements of that airworthiness directive.

AIRMAN INFORMATION, ADVISORIES, AND NOTICES - FAA AIRMAN'S INFORMATION MANUAL

AIRMAN'S INFORMATION MANUAL

The Airman's Information Manual (AIM) is designed

March, 1981

10-11

Section X
Safety Information

BEEHCRAFT

to provide airmen with basic flight information and ATC procedures for use in the national airspace system of the United States. It also contains items of interest to pilots concerning health and medical facts, factors affecting flight safety, a pilot/controller glossary of terms used in the Air Traffic Control System, information on safety, and accident and hazard reporting. It is revised at six-month intervals and can be purchased locally or from the Superintendent of Documents, U. S. Government Printing Office, Washington, D. C. 20402.

This document contains a wealth of pilot information. Among the subjects are:

- Controlled Air Space
- Services Available to Pilots
- Radio Phraseology and Technique
- Airport Operations
- Clearances and Separations
- Pre-flight
- Departures - IFR
- Enroute - IFR
- Arrival - IFR
- Emergency Procedures
- Weather and Icing
- Mountain Flying
- Wake Turbulence - Vortices

Medical Facts for Pilots
Bird Hazards
Good Operating Practices
Airport Location Directory

All pilots must be thoroughly familiar with and use the information in the AIM.

ADVISORY INFORMATION

NOTAMS (Notices to Airmen) are documents that have information of a time-critical nature that would affect a pilot's decision to make a flight; for example, an airport closed, terminal radar out of service, enroute navigational aids out of service, etc.

Airmen can subscribe to services to obtain FAA NOTAMS and Airman Advisories, and these are also available at FAA Flight Service Stations.

FAA ADVISORY CIRCULARS

The FAA issues advisory circulars to inform the aviation public in a systematic way of non-regulatory material of interest. Advisory Circulars contain a wealth of information with which the prudent pilot should be familiar. A complete list of current FAA advisory circulars is published in Advisory Circular

March, 1981

10-13

Section X
Safety Information

BEECHCRAFT

AC00-2, which lists advisory circulars that are for sale, as well as those distributed free of charge by the FAA, and provides ordering information. Many advisory circulars which are for sale can be purchased locally in aviation bookstores or at FBO's. Some of the advisory circulars of interest to pilots are:

- * 00-6A Aviation Weather
- 00-24 Thunderstorms
- 00-30 Rules of Thumb for Avoiding or
 Minimizing Encounters with Clear
 Air Turbulence
- * 00-45A Aviation Weather Services
- 00-46A Aviation Safety Reporting Program
- 00-50 Low Level Wind Shear
- 20-5D Plane Sense
- 20-93 Flutter Due to Ice or Foreign
 Substance on or in Aircraft Control
 Surfaces
- 20-105 Engine Power-Loss Accident
 Prevention
- 39-7 Airworthiness Directives for General
 Aviation Aircraft
- 43-12 Preventive Maintenance
- 60-4 Pilot's Spatial Disorientation

BEECHCRAFT**Section X
Safety Information**

- 60-6A Airplane Flight Manuals (AFM), Approved Manual Materials, Markings and Placards - Airplanes
- 60-9 Induction Icing - Pilot Precautions and Procedures
- 60-12 Availability of Industry-Developed Guidelines for the Conduct of the Biennial Flight Review
- 60-13 The Accident Prevention Counselor Program
- * 61-8D Instrument Rating Written Test Guide
- 61-9B Pilot Transition Courses for Complex Single-Engine and Light, Twin Engine Airplanes
- * 61-10A Private and Commercial Pilots Refresher Courses
- 61-12J Student Pilot Guide
- 61-19 Safety Hazard Associated with Simulated Instrument Flights
- * 61-21 Flight Training Handbook
- * 61-23A Pilot's Handbook of Aeronautical Knowledge
- * 61-27B Instrument Flying Handbook
- * 61-32B Private Pilot - Airplane - Written Test Guide
- * 61-34B Federal Aviation Regulations Written Test Guide for Private, Commercial and Military Pilots

Section X
Safety Information

BEECHCRAFT

- 61-47 Use of Approach Slope Indicators for Pilot Training
- * 61-54A Private Pilot Airplane - Flight Test Guide
- * 61-55A Commercial Pilot Airplane . . . Flight Test Guide
- * 61-56A Flight Test Guide - Instrument Pilot Airplane
- * 61-58 Flight Instructor Practical Test Guide
- 61-65 Part 61 (Revised) Certification Pilot and Flight Instructors
- 61-67 Hazards Associated with Spins in Airplanes Prohibited from Intentional Spinning
- * 61-70 Flight Instructor Instrument - Airplane - Written Test Guide
- * 61-71A Commercial Pilot Airplane Written Test Guide
- * 61-72A Flight Instructor - Airplane Written Test Guide
- 61-84 Role of Preflight Preparation
- * 67-2 Medical Handbook for Pilots
- 90-23D Wake Turbulence
- 90-34 Accidents resulting from Wheelbarrowing in Tricycle Gear Equipped Aircraft

BEECHCRAFT**Section X
Safety Information**

- 90-42A Traffic Advisory Practices at Non-tower airports
- 90-43D Operations Reservation for High-Density Traffic Airports
- 90-48 Pilots' role in Collision Avoidance
- 90-64 Automated Radar Terminal System (ARTS) III
- 90-66 Recommended Standard Traffic Patterns for Airplane Operations at Uncontrolled Airports
- 91-6A Water, Slush and Snow on runway
- 91-8A Use of Oxygen by General Aviation Pilots/Passengers
- 91-11B Annual Inspection Reminder
- 91-13C Cold Weather Operation of Aircraft
- 91-17 The use of View Limiting Devices on Aircraft
- * 91-23A Pilot's Weight and Balance Handbook
- 91-24 Aircraft Hydroplaning or Aquaplaning on Wet Runways
- 91-25A Loss of Visual Cues During Low Visibility Landings
- 91-28 Unexpected Opening of Cabin Doors

Section X
Safety Information

BEECHCRAFT

- 91-33 Use of Alternate Grades of Aviation Gasoline for Grade 80/87
- 91-35 Noise, Hearing Damage, and Fatigue in General Aviation Pilots
- 91-43 Unreliable Airspeed Indications
- 91-46 Gyroscopic Instruments - Good Operating Practices
- 91-51 Airplanes Deice and Anti-Ice Systems
- 103-4 Hazard Associated with Sublimation of Solid Carbon Dioxide (Dry Ice) Aboard Aircraft
- 150/
- 5200-3A Bird Hazards to Aircraft
- 210-1A National Notice to Airmen System
- 210-5 Military Flying Activities

* Advisory Circulars that are for sale.

FAA GENERAL AVIATION NEWS

FAA General Aviation News is published by the FAA in the interest of flight safety. The magazine is designed to promote safety in the air by calling the attention of general aviation airmen to current technical, regulatory and procedural matters affecting the safe operation of aircraft. FAA General Aviation News is sold on subscription by the

Superintendent of Documents, Government Printing
Office, Washington, D. C. 20402.

FAA ACCIDENT PREVENTION PROGRAM

The FAA assigns accident prevention specialists to each Flight Standards and General Aviation District Office to organize accident prevention program activities. In addition, there are over 3,000 volunteer airmen serving as accident prevention counselors, sharing their technical expertise and professional knowledge with the general aviation community. The FAA conducts seminars and workshops, and distributes invaluable safety information under this program.

Usually the airport manager, the FAA Flight Service Stations (FSS), or Fixed Base Operator (F.B.O.), will have a list of accident prevention counselors and their phone numbers available. All Flight Standards and General Aviation District Offices have a list of the counselors serving the district.

Before flying over unfamiliar territory, such as mountainous terrain or desert areas, it is advisable for transient pilots to consult with local counselors. They will be familiar with the more desirable routes, the wind and weather conditions, and the service and emergency landing areas that are available along

the way. They can also offer advice on the type of emergency equipment you should be carrying.

GENERAL INFORMATION ON SPECIFIC TOPICS

FLIGHT PLANNING

F.A.R. Part 91 requires that each pilot in command, before beginning a flight, familiarize himself with all available information concerning that flight.

Obtain a current and complete pre-flight briefing. This should consist of local, enroute and destination weather and enroute navaid information. Enroute terrain and obstructions, alternate airports, airport runways active, length of runways, and take-off and landing distances for the airplane for conditions expected should be known.

The prudent pilot will review his planned enroute track and stations and make a list for quick reference. It is strongly recommended a flight plan be filed with Flight Service Stations, even though the flight may be VFR. Also, advise Flight Service Stations of changes or delays of one hour or more and remember to close the flight plan at destination.

The pilot must be completely familiar with the performance of the airplane and performance data in the Information Manual. The resultant effect of temperature and pressure altitude must be taken into account in determining performance if not accounted for on the charts. An applicable FAA Approved Flight Manual, if one is provided, must be aboard the airplane at all times including the weight and balance forms and equipment list.

PASSENGER INFORMATION CARDS

Beech has available, for most current production airplanes, passenger information cards which contain important information on the proper use of restraint systems, oxygen masks, emergency exits and emergency bracing procedures. Passenger information cards may be obtained at any Beechcraft Aviation or Aero Center. A pilot should not only be familiar with the information contained in the cards himself, but should, prior to flight, always inform passengers of the information contained in the information cards. If a passenger information card is not available for your model of airplane, the pilot should orally brief the passengers on the proper use of restraint systems, doors and emergency exits, and other emergency procedures, as required by Part 91 of the FAR's.

INSPECTIONS - MAINTENANCE

In addition to maintenance inspections and pre-flight information required by F.A.R. Part 91, a complete pre-flight inspection is imperative. It is the responsibility of the owner and the operator to assure that the airplane is maintained in an airworthy condition and that proper maintenance records are kept.

Each airplane has a checklist for the pre-flight inspection which must be followed. **USE THE CHECKLIST!**

FLIGHT OPERATIONS

GENERAL

The pilot must be thoroughly familiar with all information published by the manufacturer concerning the airplane, and is required by law to operate the airplane in accordance with the FAA Approved Airplane Flight Manual and/or placards installed.

TURBULENT WEATHER

A complete and current weather briefing is a requirement for a safe trip.

Updating of weather information enroute is also essential. The wise pilot knows that weather conditions can change quickly, and treats weather forecasting as professional advice, rather than an absolute fact. He obtains all the advice he can, but stays alert to any sign or report of changing conditions.

Plan the flight to avoid areas of severe turbulence and thunderstorms. It is not always possible to detect individual storm areas or find the in-between clear areas.

Thunderstorms, squall lines and violent turbulence should be regarded as extremely dangerous and must be avoided. Hail and tornadic wind velocities can be encountered in thunderstorms that can destroy any airplane, just as tornadoes destroy nearly everything in their path on the ground.

Turboprop Engines - Thunderstorms also pose the possibility of a lightning strike on an aircraft. Any structure or equipment which shows evidence of a lightning strike, or of being subjected to a high current flow due to a strike, or is a suspected part of a lightning strike path through the aircraft, should be thoroughly inspected and any damage repaired prior to additional flight. The Pratt & Whitney or

AiResearch Engine Maintenance Manual and Hartzell Service Letter No. 104 include inspection and maintenance requirements for engines and propellers involved in lightning strike incidents.

A roll cloud ahead of a squall line or thunderstorm is visible evidence of violent turbulence; however, the absence of a roll cloud should not be interpreted as denoting that severe turbulence is not present.

Even though flight in severe turbulence must be avoided, flight in turbulent air may be encountered unexpectedly under certain conditions.

The following recommendations should be observed for airplane operation in turbulent air:

Flying through turbulent air presents two basic problems, the answer to both of which is proper airspeed. On one hand, if you maintain an excessive airspeed, you run the risk of structural damage or failure; on the other hand, if your airspeed is too low, you may stall.

If turbulence is encountered, reduce speed to the turbulent air penetration speed, if given, or to the maneuvering speed, which is listed in the Limitations Section of the Information Manual. These speeds give the best assurance of avoiding

excessive stress loads, and at the same time providing the proper margin against inadvertent stalls due to gusts.

Beware of overcontrolling in attempting to correct for changes in attitude; applying control pressure abruptly will build up G-forces rapidly and could cause structural damage or even failure. You should watch particularly your angle of bank, making turns as wide and shallow as possible. Be equally cautious in applying forward or back pressure to keep the nose level. Maintain straight and level attitude in either up or down drafts. Use trim sparingly to avoid being grossly out of trim as the vertical air columns change velocity and direction. If necessary to avoid excessive airspeeds, lower the landing gear.

FLIGHT IN ICING CONDITIONS

Every pilot of Beech airplanes (for that matter the pilot of any airplane) should be intimately acquainted with the FAA Approved National Weather Service definitions for ice intensity and accumulation which we have reprinted below:

INTENSITY

ICE ACCUMULATION

Trace	Ice becomes perceptible. Rate of accumulation slightly greater than rate
-------	--

INTENSITY

ICE ACCUMULATION (Cont'd)

Trace
(Cont'd) of sublimation. It is not hazardous even though deicing/anti-icing equipment is not utilized, unless encountered for an extended period of time (over 1 hour).

Light The rate of accumulation may create a problem if flight is prolonged in this environment (over 1 hour). Occasional use of deicing/anti-icing equipment removes/prevents accumulation. It does not present a problem if the deicing/anti-icing equipment is used.

Moderate The rate of accumulation is such that even short encounters become potentially hazardous and use of deicing/anti-icing equipment or diversion is necessary.

Severe The rate of accumulation is such that deicing/anti-icing equipment fails to reduce or control the hazard. Immediate diversion is necessary.

It is no longer unusual to find deicing and anti-icing equipment on a wide range of airplane sizes and

types. Since the capability of this equipment varies, it becomes the pilot's primary responsibility to understand limitations which restrict the use of his airplane in icing conditions and the conditions which may exceed the systems capacity.

Pilots and airplane owners must carefully review the Information Manual in order to ascertain the required operable equipment needed for flight in icing conditions. In addition, they must ascertain from the same sources the limits of approval or certification of their airplane for flight in icing conditions, and plan the flight accordingly, if icing conditions are known or forecast along the route.

Every owner and pilot of an airplane should understand that it is not uncommon to find aircraft equipped with less than the full complement of available systems and equipment. For example, props and pitot tube may be protected, but the aircraft might not have wing boots or tail boots. The reverse might be true. Windshield, pitot and airfoil surfaces might be protected, but the props might not be. Before undertaking any flight into areas where icing conditions might be suspected, inspect the aircraft and review the Information Manual to be certain that you are supported by the full complement of required IFR and deicing/anti-icing equipment.

Section X
Safety Information

BEECHCRAFT

Remember that regardless of its combination of deicing/anti-icing equipment, any aircraft not fully equipped and functional for IFR flight is not properly equipped for flight in icing conditions.

An airplane which is not approved or certificated for flight in icing conditions, not fully equipped, or which does not have all critical areas protected in the required manner by fully operational equipment must not be exposed to icing encounters of any intensity. When icing is detected, the pilot of such an aircraft must make an immediate diversion by flying out of the area of visible moisture or going to an altitude where icing is not encountered.

Some models of Beech airplanes were approved for flight in certain limited icing conditions under the FAA's Bureau of Flight Standards Release No. 434. Under this release, properly equipped airplanes are approved for flight in light to moderate icing conditions only. These aircraft are not approved for extended flight in moderate icing conditions or flights in any severe icing conditions. Flight in these conditions must be avoided.

Even airplanes fully equipped and certified for flight in the icing conditions described in Appendix C to FAR Part 25 must avoid flights into those conditions defined by the National Weather Service as

“Severe”. The National Weather Service definition of “severe icing” describes that condition as: “the rate of accumulation is such that deicing/anti-icing equipment fails to reduce or control the hazard.” No airplane equipped with any combination of deicing/anti-icing equipment can be expected to cope with such conditions. As competent pilots know, there appear to be no predictable limits for the severest weather conditions. For essentially the same reasons that airplanes, however designed or equipped for IFR flight, cannot be flown safely into conditions such as thunderstorms, tornados, hurricanes or other phenomena likely to produce severe turbulence, airplanes equipped for flight in icing conditions cannot be expected to cope with “severe” icing conditions as defined by the National Weather Service. The prudent pilot must remain alert to the possibility that icing conditions may become “severe”, and that his equipment will not cope with them. At the first indication that such condition may have been encountered or may lie ahead, he should immediately react by selecting the most expeditious and safe course for diversion.

Every pilot of a properly and fully-equipped Beech airplane who ventures into icing conditions must maintain the minimum speed (KIAS) for operation in icing conditions, which is set forth in the Normal Procedures Section of his Information Manual. If a

Section X
Safety Information

BEECHCRAFT

minimum speed for flight in icing conditions is not specified in the manual, the following indicated airspeeds must be maintained:

All Baron and Travel Air Models - 130 KIAS

All other Beechcraft twin-engine models - 140 KIAS

The pilot must remain aware of the fact that if he allows his airspeed to deteriorate below this minimum speed, he will increase the angle of attack of his airplane to the point where ice may build up on the under side of the wings aft of the area protected by the boots.

The fact or extent of ice build-up in unprotected areas will not be directly observable from the cockpit. Due to distortion of the wing airfoil, increased drag and reduced lift, stalling speeds will increase as ice accumulates on the airplane. For the same reasons, stall warning devices are not accurate and cannot be relied upon in icing conditions.

Even though the pilot maintains the prescribed minimum speed for operating in icing conditions, ice is still likely to build up on other unprotected areas (the fuselage and the unprotected wing leading edge inboard of the engine nacelle). Under some atmospheric conditions, it may even build up aft of

the boots despite the maintenance of the prescribed minimum speed. The effect of ice accumulation on any unprotected surface is aggravated by the length of exposure to the icing conditions. Ice buildup on unprotected surfaces will increase drag, add weight, reduce lift, and generally, adversely affect the aerodynamic characteristics and performance of the airplane. It can progress to the point where the airplane is no longer capable of flying. Therefore, the pilot operating even a fully-equipped airplane in sustained icing conditions must remain sensitive to any indication, such as observed ice accumulation, loss of airspeed, the need for increased power, reduced rate of climb, or sluggish response, that ice is accumulating on unprotected surfaces and that continued flight in these conditions is extremely hazardous, regardless of the performance of the deicing/anti-icing equipment.

Rapid cycling of the deice boots or cycling before at least one-quarter inch (1/4") of ice has accumulated (measured in the chordwise direction or forward from the leading edge), may cause the ice to grow outside the contour of the inflated boots and prevent ice removal.

For any owner or pilot whose use pattern for an aircraft exposes it to icing encounters, the following references are required reading for safe flying:

The aircraft's Information Manual, especially the sections on Normal Procedures, Emergency Procedures, Systems, and Safety Information.

FAA Advisory Circular 91-51 - Airplane Deice and Anti-ice Systems.

Weather Flying, by Robert N. Buck.

Finally, the most important ingredients to safe flight in icing conditions - regardless of the aircraft or the combination of deicing/anti-icing equipment - are a complete and current weather briefing, sound pilot judgment, close attention to the rate and type of ice accumulations, and the knowledge that "severe icing" as defined by the National Weather Service is beyond the capability of modern aircraft and immediate diversion must be made. It is the inexperienced or uneducated pilot who presses on "regardless", hoping that steadily worsening conditions will improve, only to find himself flying an airplane which has become so loaded with ice

that he can no longer maintain altitude. At this point he has lost most, if not all, of his safety options, including perhaps a 180 degree turn to retreat along the course already traveled. The responsible and well-informed pilot recognizes the limitations of weather conditions, his airplane and its systems and reacts promptly; he lives to fly again.

MOUNTAIN FLYING

Pilots flying in mountainous areas should inform themselves of all aspects of mountain flying, including the effects of topographic features on weather conditions. Many good articles have been published, and a synopsis of mountain flying operations is included in the FAA Airman's Information Manual, Part I.

Avoid flight at low altitudes over mountainous terrain, particularly near the lee slopes. If the wind velocity near the level of the ridge is in excess of 25 knots and approximately perpendicular to the ridge, mountain wave conditions are likely over and near the lee slopes. If the wind velocity at the level of the ridge exceeds 50 knots, a strong mountain wave is probable with extreme up and down drafts and severe turbulence. The worst turbulence will be encountered in and below the rotor zone, which is

usually 8 to 10 miles downwind from the ridge. This zone is sometimes characterized by the presence of "roll clouds" if sufficient moisture is present; altocumulus standing lenticular clouds are also visible signs that a mountain wave exists, but their presence is likewise dependent on moisture. Mountain wave turbulence can, of course, occur in dry air and the absence of such clouds should not be taken as any assurance that mountain wave turbulence will not be encountered. A mountain wave downdraft may exceed the climb capability of your airplane. Avoid mountain wave downdrafts.

VFR - LOW CEILINGS

If you are not instrument rated, do not attempt "VFR on Top" or "Special VFR" flight or clearances. Being caught above a solid cloud layer when an emergency descent is required (or at destination) is an extremely hazardous position for the VFR pilot. Accepting a clearance out of certain airport control zones with no minimum ceiling and one-mile visibility as permitted with "Special VFR" is a foolish practice for the VFR pilot.

Avoid areas of low ceilings and restricted visibility unless you are instrument rated and proficient and have an instrument equipped airplane. Then proceed with caution and with planned alternates.

VFR AT NIGHT

When flying VFR at night, in addition to the altitude appropriate for the direction of flight, pilots should maintain a safe minimum altitude as dictated by terrain, obstacles such as TV towers, or communities in the area flown. This is especially true in mountainous terrain, where there is usually very little ground reference. Minimum clearance is 2,000 feet above the highest obstacle enroute. Do not depend on your ability to see obstacles in time to miss them. Flight on dark nights over sparsely populated country can be the same as IFR, and must be avoided by inexperienced or non-IFR rated pilots.

VERTIGO - DISORIENTATION

Disorientation can occur in a variety of ways. During flight, inner ear balancing mechanisms are subjected to varied forces not normally experienced on the ground. This, combined with loss of outside visual reference, can cause vertigo. False interpretations (illusions) result, and may confuse the pilot's conception of the altitude and position of his airplane.

Under VFR conditions, the visual sense, using the horizon as a reference, can override the illusions. Under low visibility conditions (night, fog, clouds,

haze, etc.) the illusions predominate. Only through awareness of these illusions, and proficiency in instrument flight procedures, can an airplane be operated safely in a low visibility environment.

Flying in fog, dense haze or dust, cloud banks, or very low visibility, with strobe lights or rotating beacons turned on can contribute to vertigo. They should be turned off in these conditions, particularly at night.

All pilots should check the weather and use good judgment in planning flights. The VFR pilot should use extra caution in avoiding low visibility conditions.

Motion sickness often precedes or accompanies disorientation and may further jeopardize the flight.

Disorientation in low visibility conditions is not limited to VFR pilots. Although IFR pilots are trained to look at their instruments to gain an artificial visual reference as a replacement for the loss of a visual horizon, they do not always do so. This can happen when the pilot's physical condition will not permit him to concentrate on his instruments; when the pilot is not proficient in flying instrument conditions in the airplane he is flying; or, when the pilot's work load of flying by reference to

his instruments is augmented by such factors as turbulence. Even an instrument rated pilot encountering instrument conditions, intentional or unintentional, should ask himself whether or not he is sufficiently alert and proficient in the airplane he is flying, to fly under low visibility conditions and the turbulence anticipated or encountered. If any doubt exists, the flight should not be made or it should be discontinued as soon as possible.

The result of vertigo is loss of control of the airplane. If the loss of control is sustained it will result in an excessive speed accident. Excessive speed accidents occur in one of two manners, either as an inflight airframe separation or as a high speed ground impact; and they are fatal accidents in either case. All airplanes are subject to this form of accident.

For years, Beech Information Manuals have contained instructions that the landing gear should be extended in any circumstance in which the pilot encounters IFR conditions which approach the limits of his capability or his ratings. Lowering the gear in IFR conditions or flight into heavy or severe turbulence, tends to stabilize the aircraft, assists in maintaining proper airspeed, and will substantially reduce the possibility of reaching excessive

airspeeds with catastrophic consequences, even where loss of control is experienced.

Excessive speed accidents occur at airspeeds greatly in excess of two operating limitations which are specified in the manuals: Maximum maneuvering speed and the "red line" or "never exceed" speed. Such speed limits are set to protect the structure of an airplane. For example, control surfaces are designed to be used to their fullest extent only below a certain speed - maximum maneuvering speed. As a result, the control surfaces should never be suddenly or fully deflected above maximum maneuvering speed. Turbulence penetration should not be performed above that speed. The accidents we are discussing here occur at airspeeds greatly in excess of these limitations. No airplane should ever be flown beyond its FAA approved operating limitations.

FLIGHT OF MULTI-ENGINE AIRPLANES WITH ONE ENGINE INOPERATIVE.

The major difference between flying a twin-engine and single-engine airplane is knowing how to manage the flight if one engine loses power for any reason. Safe flight with one engine out requires an

understanding of the basic aerodynamics involved - as well as proficiency in engine out procedures.

Loss of power from one engine affects both climb performance and controllability of any light twin. Climb performance depends on an excess of power over that required for level flight. Loss of power from one engine obviously represents a 50% loss of horsepower but, in virtually all light twins, climb performance is reduced by at least 80%. A study of the charts in your Information Manual will confirm this fact.

Single engine climb performance depends on four factors:

Airspeed	too little, or too much, will decrease climb performance.
Drag	gear, flaps, cowl flaps, prop, and speed.
Power	amount available in excess of that needed for level flight.
Weight	passengers, baggage, and fuel load greatly affect climb performance.

Loss of power on one engine creates yaw due to

asymmetrical thrust. Yaw forces must be balanced with the rudder. Loss of power on one engine also reduces prop wash over the wing. In addition, yaw affects the lift distribution over the wing causing a roll toward the "dead" engine. These roll forces may be balanced by banking slightly (up to 5°) into the operating engine.

Airspeed is the key to safe single engine operations. For most light twins there is an:

	<u>Symbol</u>
- airspeed below which directional control cannot be maintained	V _{mca}
- airspeed below which an intentional engine cut should never be made	V _{sse}
- airspeed that will give the best single engine rate-of-climb (or the slowest loss of altitude)	V _{yse}
- airspeed that will give the steepest angle-of-climb with one engine-out	V _{xse}

MINIMUM CONTROL SPEED AIRBORNE (Vmca)

Vmca is designated by the red radial on the airspeed indicator and indicates the minimum control speed, airborne at sea level. Vmca is determined by FAA regulations as the minimum airspeed at which it is possible to recover directional control of the airplane within 20 degrees heading change, and thereafter maintain straight flight, with not more than 5 degrees of bank if one engine fails suddenly with:

- Take-off power on both engines,
- Rearmost allowable center of gravity,
- Flaps in takeoff position,
- Landing gear retracted,
- Propeller windmilling in takeoff pitch configuration (or feathered if automatically featherable).

However, sudden engine failures rarely occur with all of the factors listed above, and therefore, the actual Vmca under any particular situation may be a little slower than the red radial on the airspeed

indicator. Most airplanes will not maintain level flight at speeds at or near V_{mca} . Consequently, it is not advisable to fly at speeds approaching V_{mca} , except in training situations or during flight tests. Adhering to the practice of never flying at or below the published V_{mc} speed for your aircraft will virtually eliminate loss of directional control as a problem in the event of engine failure.

INTENTIONAL ONE-ENGINE INOPERATIVE SPEED
(V_{sse})

V_{sse} is specified by the airplane manufacturer and is the minimum speed at which to perform intentional engine cuts. Use of V_{sse} is intended to reduce the accident potential from loss of control after engine cuts at or near minimum control speed. V_{mca} demonstrations are necessary in training, but should only be made at a safe altitude above the terrain and with the power reduction on one engine made at or above V_{sse} .

BEST SINGLE ENGINE RATE-OF-CLIMB SPEED
(V_{yse})

V_{yse} is designated by the blue radial on the airspeed indicator. V_{yse} delivers the greatest gain in altitude

in the shortest possible time, and is based on the following criteria:

- critical engine inoperative, and its propeller in the minimum drag position.
- operating engine set at not more than maximum continuous power.
- landing gear retracted.
- wing flaps in the most favorable (i.e., best lift/drag ratio position).
- cowl flaps as required for engine cooling.
- aircraft flown at recommended bank angle.

Drag caused by a windmilling propeller, extending landing gear, or flaps in the landing position, will severely degrade or destroy single engine climb performance. Since engine climb performance varies widely with type of airplane, weight, temperature, altitude, and airplane configuration, the climb gradient (altitude gain or loss per mile) may be marginal - or even negative - under some conditions. Study the Information Manual for your specific airplane and know what performance to expect with one-engine out.

***BEST SINGLE ENGINE ANGLE-OF-CLIMB
AIRSPEED (V_{xse})***

V_{xse} is used only to clear obstructions during initial

climb-out as it gives the greatest altitude gain per unit of horizontal distance. It provides less engine cooling and requires more rudder control than Vyse.

SINGLE ENGINE SERVICING CEILING

The single engine service ceiling is the maximum altitude at which an airplane will climb, at a rate of at least 50 feet per minute in smooth air, with one engine feathered.

The single engine service ceiling chart should be used during flight planning to determine whether the airplane, as loaded, can maintain the Minimum Enroute Altitude (MEA) if IFR, or terrain clearance if VFR, following an engine failure.

BASIC SINGLE ENGINE PROCEDURES

Know and follow, to the letter, the single-engine emergency procedures specified in your Information Manual for your specific make and model airplane. However, the basic fundamentals of all the procedures are as follows:

- Maintain aircraft control and airspeed at all times. This is cardinal rule No. 1.
- Usually, apply maximum power to the operating engine. However, if the engine failure occurs at

a speed below V_{mca} , or during cruise or in a steep turn, you may elect to use only enough power to maintain a safe speed and altitude. If the failure occurs on final approach, use power only as necessary to complete the landing.

- Reduce drag to an absolute minimum.
- Secure the failed engine and related sub-systems.

The first three steps should be done promptly and from memory. The check list should then be consulted to be sure that the inoperative engine is secured properly and that the appropriate switches are placed in the correct position. The airplane must be banked about 5° into the live engine, with the "slip/skid" ball out of center toward the live engine, to achieve rated performance.

Another note of caution: Be sure to identify the dead engine, positively, before feathering it. Remember: First, identify the suspected engine (i.e., "Dead foot means dead engine"), second, verify with cautious throttle movement, then feather.

ENGINE FAILURE ON TAKE-OFF

If an engine fails before attaining lift-off speed, or below V_{mca} , the only proper action is to discontinue

the take-off. If the engine fails after lift-off with the landing gear still down, the take-off should still be discontinued if touch-down and roll-out on the remaining runway is still possible.

If you do find yourself in a position of not being able to climb, it is much better to pull the power on the good engine and land straight ahead than try to force a climb and lose control.

Your Information Manual contains charts that are used in calculating the runway length required to stop if the engine fails before reaching lift-off speed and also has charts showing single engine performance after lift-off.

Study your charts carefully. No airplane is capable of climbing out on one engine under all weight, pressure altitude, and temperature conditions. Know, before you take the actual runway, whether you can maintain control and climb-out if you lose an engine while the gear is still down. It may be necessary to off-load some weight, or wait for more favorable temperature or wind conditions.

WHEN TO FLY V_x , V_y , V_{xse} and V_{yse}

During normal two-engine operations, always fly V_y (V_x if necessary for obstacle clearance) on initial

climb-out. Then, accelerate to your cruise climb airspeed, which may be V_y plus 10 to 15 knots after you have obtained a safe altitude. Use of cruise climb airspeed will give you better engine cooling, increased inflight visibility and better fuel economy. However, at the first indication of an engine failure during climb-out, or while on approach, establish V_{yse} or V_{xse} , whichever is appropriate. (Consult your Information Manual for specifics).

STALLS, SLOW FLIGHT AND TRAINING

The stall warning system must be kept operational at all times and must not be deactivated by interruption of circuits, circuit breakers, or fuses. Compliance with this requirement is especially important in all high performance single and multi-engine airplanes during engine-out practice, or stall demonstrations, because the stall speed is critical in all low speed operations of high-performance airplanes.

Training should be accomplished under the supervision of a qualified instructor-pilot; with careful reference to the applicable sections of the FAA Flight Test Guide and FAA Pilot Transition Courses for Complex Single Engine and Light Twin Engine Airplanes (AC61-9B). In particular, observe carefully the warnings in the flight test guides.

The single engine stall speed of a twin engine aircraft is generally slightly below the power off (engines idle) stall speed, for a given weight condition. Single engine stalls in multi-engine airplanes are not recommended. Single engine stalls have never been required by the FAA regulations for multi-engine flight tests, and should not be practiced in high performance airplanes by other than qualified engineering test pilots.

Engine out minimum control speed demonstrations in multi-engine airplanes should be conducted in

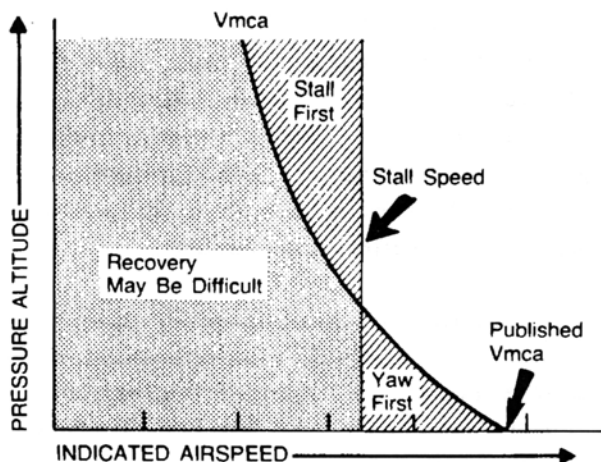

Relationship Between Stall Speed And Vmca For Aircraft With Normally Aspirated Engines.

STD 601-38

strict accordance with the warning of the FAA Flight Test Guide. Engine out minimum control speed generally decreases with altitude, while the single engine stall speed remains approximately constant, for normally aspirated engines. No such demonstration should be attempted when the density altitude and temperature are such that the engine out minimum control speed is known, or discovered to be, close to the stalling speed. Loss of directional or lateral control, just as a stall occurs, is potentially hazardous.

V_{se}, the airspeed below which an engine should not be intentionally rendered inoperative for practice purposes, was established because of the apparent practice of some pilots, instructors, and examiners, of intentionally rendering an engine inoperative at a time when the airplane is being operated at a speed close to, or below the power idle stall speed. Unless the pilot takes immediate and proper corrective action under such circumstances, it is possible to enter an inadvertent spin.

It is recognized that flight below V_{se} with one engine inoperative, or simulated inoperative, may be required for conditions such as practice demonstration of V_{mca} for multi-engine pilot certification. Refer to the procedure set forth in the Information Manual for your aircraft. This

procedure calls for simulating one engine inoperative by reducing the power lever (throttle) on one engine to idle while operating at an airspeed above V_{sse} . Power on the other engine is set at maximum, then airspeed is reduced at approximately one knot per second until either V_{mca} or stall warning is obtained. During this transition, rudder should be used to maintain directional control, and ailerons should be used to maintain a 5° bank toward the operative engine. At the first sign of either V_{mca} or stall warning (which may be evidenced by inability to maintain longitudinal, lateral or directional control, aerodynamic stall buffet, or stall warning horn sound), recovery must be initiated immediately by reducing power to idle on operative engine and lowering the nose to regain V_{sse} . Resume normal flight. This entire procedure should be used at a safe altitude of at least 5,000 feet above the ground in clear air only.

If stall warning is detected prior to the first sign of V_{mca} , an engine-out minimum control speed demonstration cannot be accomplished under the existing density altitude and gross weight conditions and should not be attempted.

SPINS

A major cause of fatal accidents in general aviation

aircraft is a stall and spin. Stall demonstrations and practice are a means for a pilot to acquire the skills to recognize when a stall is about to occur and to recover as soon as the first signs of a stall are evident. If a stall does not occur - A spin cannot occur. It is important to remember however, that a stall can occur in any flight attitude, at any airspeed, if controls are misused.

Unless your aircraft has been specifically certificated in the aerobatic category and specifically tested for spin recovery characteristics, it is placarded against intentional spins. The pilot of an airplane placarded against intentional spins should assume that the airplane may become uncontrollable in a spin, since its performance characteristics beyond certain limits specified in the FAA regulations may not have been tested and are unknown. This is why aircraft are placarded against intentional spins, and this is why stall avoidance is your protection against an inadvertent spin.

Pilots are taught that intentional spins are entered by deliberately inducing a yawing movement with the controls as the aircraft is stalled. Inadvertent spins result from the same combination - stall plus yaw. That is why it is important to use coordinated controls and to recover at the first indication of a stall when practicing stalls.

In any twin engine airplane, fundamental aerodynamics dictate that if the airplane is allowed to become fully stalled while one engine is providing lift-producing thrust the yawing movement which can induce a spin will be present. Consequently, it is important to immediately reduce power on the operating engine, lower the nose to reduce the angle of attack, and increase the airspeed to recover from the stall. In any twin engine aircraft, if application of stall recovery controls is delayed a rapid rolling and yawing motion may develop, even against full aileron and rudder, resulting in the airplane becoming inverted during the onset of a spinning motion. Once the airplane has been permitted to progress beyond the stall and is allowed to reach the rapid rolling and yawing condition, the pilot must then immediately initiate the generally accepted spin recovery procedure for multi-engine airplanes, which is as follows:

Immediately move the control column full forward, apply full rudder opposite to the direction of the spin and reduce power on both engines to idle. These three actions should be done as near simultaneously as possible; then continue to hold this control position until rotation stops and then neutralize all controls and execute a

smooth pullout. Ailerons should be neutral during recovery. THE LONGER THE PILOT DELAYS BEFORE TAKING PROPER CORRECTIVE ACTION, THE MORE DIFFICULT RECOVERY WILL BECOME.

Always remember that extra alertness and pilot techniques are required for slow flight maneuvers, including the practice or demonstration of stalls or Vmca. In addition to the foregoing mandatory procedures, always:

1. Be certain that the center of gravity of the airplane is as far forward as possible. Forward C.G. aids stall recovery, spin avoidance and spin recovery. An aft C.G. can create a tendency for a spin to flatten out, which delays recovery.
2. Whenever a student pilot will be required to practice slow flight or single-engine maneuvers, be certain that the qualified instructor pilot has a full set of operable controls in front of him. FAA regulations prohibit flight instruction without full dual controls.
3. Conduct any maneuvers which could possibly result in a spin at altitudes in excess of five thousand (5,000) feet above ground level in clear air only.

4. Remember that an airplane, at or near traffic pattern and approach altitudes, cannot recover from a spin, or perhaps even a stall, before impact with the ground. For twin engine aircraft, when descending to traffic altitude and during pattern entry and all other flight operations, maintain speed no lower than V_{sse} . On final approach maintain at least the airspeed shown in the flight manual. Should a go-around be required, do not apply more power than necessary until the airplane has accelerated to V_{sse} . Recognize that under some conditions of weight, density altitude, and aircraft configuration, a twin engine aircraft cannot climb or accelerate on a single engine. Hence a single engine go-around is impossible and the aircraft is committed to a landing. Plan your approach accordingly.
5. Remember that if an airplane flown under instrument conditions is permitted to stall or enter a spin, the pilot, without reference to the horizon, is certain to become disoriented. He may be unable to recognize a stall, spin entry, or the spin condition and he may be unable to determine even the direction of the rotation.
6. Finally, never forget that stall avoidance is your best protection against an inadvertent spin.
MAINTAIN YOUR AIRSPEED.

DESCENT

In piston-powered airplanes, whether single or twin engines, supercharged or normally aspirated, it is necessary to avoid prolonged descents with low power, as this produces two problems: (1) Excessively cool cylinder head temperatures which cause premature engine wear, and (2) excessively rich mixtures due to idle enrichment (and altitude) which causes soot and lead deposits on the spark plugs (fouling). The second of these is the more serious consideration; the engine may not respond to the throttle when it is desired to discontinue the descent.

Both problems are amenable to one solution: maintain adequate power to keep cylinder head temperatures in the "green" range during descent, and lean to best power mixture (that is, progressively enrich the mixture from cruise only slightly as altitude decreases). This procedure will lengthen the descent, of course, and requires some advance planning.

If it is necessary to make a prolonged descent at or near idle, as in practicing forced landings, at least avoid the problem of fouled spark plugs by frequently advancing the throttle until the engine runs smoothly, and maintain an appropriate mixture

setting with altitude. (Refer to pre-landing check list.)

VORTICES - WAKE TURBULENCE

Every airplane generates wakes of turbulence while in flight. Part of this is from the propeller or jet engine, and part from the wing tip vortices. The larger and heavier the airplane, the more pronounced and turbulent the wakes will be. Wing tip vortices from large, heavy airplanes are very severe at close range, degenerating with time, wind, and space. These are rolling in nature, from each wing tip. In tests, vortex velocities of 133 knots have been recorded.

Encountering the rolling effect of wing tip vortices within two minutes after passage of large airplanes is most hazardous to light airplanes. This roll effect can exceed the maximum counter roll obtainable in a light airplane.

The turbulent areas may remain for as long as three minutes or more, depending on wind conditions, and may extend several miles beyond the airplane. Plan to fly slightly above and to the windward side of the other airplanes. Because of the wide variety of conditions that can be encountered, there is no set rule to follow to avoid wake turbulence in all

situations. However, the Airman's Information Manual, and to a greater extent Advisory Circular 90-23, Aircraft Wake Turbulence, provides a thorough discussion of the factors you should be aware of when wake turbulence may be encountered.

TAKEOFF AND LANDING CONDITIONS

When taking off on runways covered with water or freezing slush, the landing gear should remain extended for approximately ten seconds longer than normal, allowing the wheels to spin and dissipate the freezing moisture. The landing gear should then be cycled up, then down, wait approximately five seconds and then retract again.

Caution must be exercised to insure that the entire operation is performed below Maximum Landing Gear Operating Airspeed.

Use caution when landing on runways that are covered by water or slush which cause hydroplaning (aquaplaning), a phenomenon that renders braking and steering ineffective because of the lack of sufficient surface friction. Snow and ice covered runways are also hazardous. The pilot should also be alert to the possibility of the brakes freezing.

Use caution when taking off or landing during gusty wind conditions. Also be aware of the special wind conditions caused by buildings or other obstructions located near the runway in a crosswind pattern.

MEDICAL FACTS FOR PILOTS

GENERAL

When the pilot enters the airplane, he becomes an integral part of the man-machine system. He is just as essential to a successful flight as the control surfaces. To ignore the pilot in pre-flight planning would be as senseless as failing to inspect the integrity of the control surfaces or any other vital part of the machine. The pilot himself has the responsibility for determining his reliability prior to entering the airplane for flight. When piloting an airplane, an individual should be free of conditions which are harmful to alertness, ability to make correct decisions, and rapid reaction time.

FATIGUE

Fatigue generally slows reaction times and causes errors due to inattention. In addition to the most common cause of fatigue; insufficient rest and loss of sleep, the pressures of business, financial

worries, and family problems can be important contributing factors. If you are tired, don't fly.

HYPOXIA

Hypoxia, in simple terms, is a lack of sufficient oxygen to keep the brain and other body tissues functioning properly. There is a wide individual variation in susceptibility to hypoxia. In addition to progressively insufficient oxygen at higher altitudes, anything interfering with the blood's ability to carry oxygen can contribute to hypoxia (anemias, carbon monoxide, and certain drugs). Also, alcohol and various drugs decrease the brain's tolerance to hypoxia.

Your body has no built-in alarm system to let you know when you are not getting enough oxygen. It is impossible to predict when or where hypoxia will occur during a given flight, or how it will manifest itself. Some of the common symptoms of hypoxia are increased breathing rate, a light-headed or dizzy sensation, tingling or warm sensation, sweating, reduced visual field, sleepiness, blue coloring of skin, fingernails, and lips, and behavior changes. A particularly dangerous feature of hypoxia is an increased sense of well-being, called euphoria. It obscures a person's ability and desire to be critical of himself, slows reaction time, and impairs thinking

ability. Consequently, an hypoxic individual commonly believes things are getting progressively better while he nears total collapse.

The symptoms are slow but progressive, insidious in onset, and are most marked at altitudes starting above ten thousand feet. Night vision, however, can be impaired starting at an altitude of 5,000 feet. Persons who have recently overindulged in alcohol, who are moderate to heavy smokers, or who take certain drugs, may be more susceptible to hypoxia. Susceptibility may also vary in the same individual from day to day or even morning to evening. Use oxygen on flights above 10,000 feet and at any time when symptoms appear.

Depending upon altitude, an hypoxic individual has a limited time to make decisions and perform useful acts, even though he may remain conscious for a longer period. If pressurization equipment fails at certain altitudes the pilot and passengers have only a certain amount of time to get an oxygen mask on before they exceed their time of useful consciousness. The time of useful consciousness is approximately 3-5 minutes at 25,000 feet of altitude in the average individual and diminishes markedly as altitude increases. At 30,000 feet altitude, for

example, the time of useful consciousness is approximately 1 to 2 minutes. Therefore, in the event of depressurization, oxygen masks should be obtained and used immediately.

Should symptoms occur that cannot definitely be identified as either hypoxia or hyperventilation, try three or four deep breaths of oxygen. The symptoms should improve markedly if the condition was hypoxia (recovery from hypoxia is rapid).

HYPERVENTILATION

Hyperventilation, or overbreathing, is a disturbance of respiration that may occur in individuals as a result of emotional tension or anxiety. Under conditions of emotional stress, fright, or pain, breathing rate may increase, causing increased lung ventilation, although the carbon dioxide output of the body cells does not increase. As a result, carbon dioxide is "washed out" of the blood. The most common symptoms of hyperventilation are: dizziness; hot and cold sensations; tingling of the hands, legs and feet; tetany; nausea; sleepiness; and finally, unconsciousness. If the symptoms persist, discontinue use of oxygen and consciously slow your breathing rate until symptoms clear, and then resume normal breathing rate. Normal breathing can be aided by talking aloud.

ALCOHOL

Common sense and scientific evidence dictate that you must not fly as a crew member while under the influence of alcohol. Alcohol, even in small amounts, produces, among other things, a dulling of critical judgment; a decreased sense of responsibility; diminished skill reactions and coordination; decreased speed and strength of muscular reflexes (even after one ounce of alcohol); decreases in efficiency of eye movements during reading (after one ounce of alcohol); increased frequency of errors (after one ounce of alcohol); constriction of visual fields; decreased ability to see under dim illuminations; loss of efficiency of sense of touch; decrease of memory and reasoning ability; increased susceptibility to fatigue and decreased attention span; decreased relevance of response; increased self confidence with decreased insight into immediate capabilities.

Tests have shown that pilots commit major errors of judgment and procedure at blood alcohol levels substantially less than the minimum legal levels of intoxication for most states. These tests further show a continuation of impairment from alcohol up to as many as 14 hours after consumption, with no appreciable diminution of impairment. The body metabolizes ingested alcohol at a rate of about one-

third of an ounce per hour. Even after the body completely destroys a moderate amount of alcohol, a pilot can still be severely impaired for many hours by hangover.

The effects of alcohol on the body are magnified at altitudes, as 2 oz. of alcohol at 18,000 feet produce the same adverse effects as 6 oz. at sea level. In other words, "the higher you get, the higher you get".

Because of the slow destruction of alcohol by the body, a pilot may still be under influence eight hours after drinking a moderate amount of alcohol. Therefore, an excellent rule is to allow at least 12 to 24 hours between "bottle and throttle", depending on the amount of alcoholic beverage consumed.

DRUGS

Self-medication or taking medicine in any form when you are flying can be extremely hazardous. Even simple home or over-the-counter remedies and drugs such as aspirin, antihistamines, cold tablets, cough mixtures, laxatives, tranquilizers, and appetite suppressors, may seriously impair the judgment and coordination needed while flying. The safest rule is to take no medicine before or while flying, except

after consultation with your Aviation Medical Examiner.

SCUBA DIVING

Flying shortly after any prolonged scuba diving could be dangerous. Under the increased pressure of the water, excess nitrogen is absorbed into your system. If sufficient time has not elapsed prior to takeoff for your system to rid itself of this excess gas, you may experience the bends at altitudes even under 10,000 feet, where most light planes fly.

CARBON MONOXIDE AND NIGHT VISION

The presence of carbon monoxide results in hypoxia which will affect night vision in the same manner and extent as hypoxia from high altitudes. Even small levels of carbon monoxide have the same effect as an altitude increase of 8,000 to 10,000 feet. Smoking several cigarettes can result in a carbon monoxide saturation sufficient to effect visual sensitivity equal to an increase of 8,000 feet altitude.

ADDITIONAL INFORMATION

In addition to the coverage of subjects in this

section, the National Transportation Safety Board and the Federal Aviation Administration periodically issue, in greater detail, general aviation pamphlets concerning aviation safety. FAA Regional Offices also publish material under the FAA General Aviation Accident Prevention Program. These can be obtained at FAA Offices, Weather Stations, Flight Service Stations or Airport Facilities, and are very good sources of information and are highly recommended for study. Some of these are titled:

Airman's Information Manual
12 Golden Rules for Pilots
Weather or Not
Disorientation
Plane Sense
Weather Info Guide for Pilots
Wake Turbulence
Don't Trust to Luck, Trust to Safety
Rain, Fog, Snow
Thunderstorm - TRW
Icing
Pilot's Weather Briefing Guide
Thunderstorms Don't Flirt . . . Skirt 'em
IFR-VFR - Either Way Disorientation Can be Fatal
IFR Pilot Exam-O-Grams
VFR Pilot Exam-O-Grams
Flying Light Twins Safely

Section X
Safety Information

BEECHCRAFT

Tips on Engine Operation in Small General Aviation
Aircraft

Estimating Inflight Visibility

Is the Aircraft Ready for Flight

Tips on Mountain Flying

Tips on Desert Flying

Always Leave Yourself An Out

Safety Guide for Private Aircraft Owners

Tips on How to Use the Flight Planner

Tips on the Use of Ailerons and Rudder

Some Hard Facts About Soft Landings

Propeller Operation and Care

Torque "What it Means to the Pilot"

Weight and Balance. An Important Safety
Consideration for Pilots

SPECIAL CONDITIONS

MAINTENANCE

Airplanes operated for Air Taxi or other than normal operation, and airplanes operated in humid tropics, or cold and damp climates, etc., may need more frequent inspections for wear, corrosion and/or lack of lubrication. In these areas, periodic inspections should be performed until the operator can set his own inspection periods based on experience.

NOTE

The required periods do not constitute a guarantee that the item will reach the period without malfunction, as the aforementioned factors cannot be controlled by the manufacturer.

Corrosion, and its effects, must be treated at the earliest possible opportunity. A clean, dry surface is virtually immune to corrosion. Make sure that all drain holes remain unobstructed. Protective films and sealants help to keep corrosive agents from contacting metallic surfaces. Corrosion inspections should be made most frequently under high-corrosion-risk operating conditions, such as in areas of excessive airborne salt concentrations (e.g., near the sea) and in high-humidity areas (e.g., tropical regions).

